

Reference Manual

DOC. REV. 3/21/2017

Iguana (VL-EPIC-25)

Intel® Atom-based SBC with
Ethernet, SATA, USB, eUSB,
CompactFlash, mSATA, Serial,
Industrial I/O, and SPX™



VERSALOGIC
CORPORATION



WWW.VERSALOGIC.COM

12100 SW Tualatin Road
Tualatin, OR 97062-7341
(503) 747-2261
Fax (971) 224-4708

Copyright © 2013-2017 VersaLogic Corp. All rights reserved.

Notice:

Although every effort has been made to ensure this document is error-free, VersaLogic makes no representations or warranties with respect to this product and specifically disclaims any implied warranties of merchantability or fitness for any particular purpose.

VersaLogic reserves the right to revise this product and associated documentation at any time without obligation to notify anyone of such changes.

PC/104 and the PC/104 logo are trademarks of the PC/104 Consortium.

Product Revision Notes

Revision 1.02 – Added EPIC-25EAR SKU

Revision 1.01 – Updated J4 connector content in Table 2.

Revision 1.00 – Commercial release.

Support

The Iguana support page, at <http://www.versalogic.com/private/iguanasupport.asp>, contains additional information and resources for this product including:

- Reference Manual (PDF format)
- Device drivers
- Data sheets and manufacturers' links for chips used in this product
- Photograph of the circuit board
- BIOS and PLD information and upgrades

This is a private page for Iguana users that can be accessed only by entering this address directly. It cannot be reached from the VersaLogic homepage.

The VersaTech KnowledgeBase is an invaluable resource for resolving technical issues with your VersaLogic product.

[VersaTech KnowledgeBase](#)

Contents

Introduction	1
Description.....	1
Features and Construction	1
Technical Specifications.....	2
Block Diagram.....	3
Thermal Considerations.....	4
CPU Die Temperature	4
Model Differences	4
RoHS Compliance	5
About RoHS.....	5
Warnings.....	5
Electrostatic Discharge	5
Lithium Battery.....	5
Handling Care.....	6
Technical Support.....	6
Repair Service.....	6
Configuration and Setup.....	8
Initial Configuration	8
Basic Setup	8
Operating System Installation.....	10
BIOS Setup Screens.....	10
Physical Details	11
Dimensions and Mounting.....	11
Iguana Dimensions	11
VL-CBR-5013 Dimensions	12
VL-CBR-4004 Dimensions	13
Hardware Assembly.....	14
Standoff Locations.....	14
External Connectors	15
Iguana Connector Locations – Top.....	15
Iguana Connector Locations – Bottom	16
Iguana Connector Functions and Interface Cables	17
VL-CBR-5013 Connector Locations	18
VL-CBR-5013 Connector Functions	18
VL-CBR-4004 Connector Locations	19
Jumper Blocks	20
Jumpers As-Shipped Configuration.....	20
Jumper Summary	21
System Features.....	22
Power Supply	22
Power Connectors.....	22

Power Requirements	22
Power Delivery Considerations	23
Lithium Battery	23
CPU	24
System RAM	25
Clearing Non-volatile RAM (NVRAM)	25
Real-Time Clock (RTC)	25
Setting the Clock	25
Clearing the Real-Time Clock	26
Console Redirection	26
Interfaces and Connectors	27
Expansion Buses	27
PC/104-Plus (PCI + ISA) and PCI-104 (PCI Only)	27
PC/104 ISA	27
PC/104 I/O Support	28
PC/104 Memory Support	28
PC/104 IRQ Support	28
Ethernet Interface	29
Ethernet Connectors	29
Ethernet Status LEDs	29
Status LED	30
SATA Interface	30
Serial Ports	31
COM Port Configuration	31
RS-485 Mode Line Driver Control	31
Serial Port Connectors	32
USB Interface	32
Flash Interfaces	33
CompactFlash	33
eUSB Socket	33
PCIe Mini Card / mSATA Socket	33
PCIe Mini Card Wireless Status LEDs	35
Video	36
SVGA Output Connector	36
LVDS Flat Panel Display Connector	37
Audio	38
User I/O Connector	39
Pushbutton Reset	40
Power Button	40
Supported Power States	40
External Speaker	41
LEDs	41
Programmable LED	41
Power LED	41
Digital I/O	42
Digital I/O Port Configuration Using the SPI Interface	42
Analog Input	47
External Connections	47

Analog Input Using the SPI Interface	47
Analog Output	49
Counter / Timers	50
SPX	51
VersaLogic SPX Expansion Modules	52
SPI Registers.....	53
System Resources and Maps	56
Legacy Memory Map.....	56
I/O Map.....	56
Special Registers	57
PLED and Product Code Register	57
PLD Revision and Type Register	58
BIOS and Jumper Status Register.....	59
Appendix A – References.....	60
Appendix B – Custom Programming	61
PLD Interrupts	61
Interrupt Control Register.....	61
Interrupt Status Register	62
8254 Timer Control Register	63
A/D and D/A Control/Status Register	64

Description

FEATURES AND CONSTRUCTION

The Iguana (VL-EPIC-25) is a feature-packed single board computer (SBC). It is designed for OEM control projects requiring compact size, high reliability, and longevity (product lifespan). Its features include:

- Intel Atom D425 Single Core or D525 Dual Core processor with ICH8M I/O hub
- Up to 2GB of DDR3 via a single SO-DIMM
- Dual Gigabit Ethernet
- PC/104-*Plus* expansion
- Eight USB 1.1/2.0 channels: two (Type A) on-board, four (Type A) on the paddleboard, one to the PCIe Mini Card, and one to the eUSB interface
- Industrial I/O
 - Eight 12-bit analog inputs
 - Four 12-bit analog outputs
 - Sixteen digital I/O lines
- Three SATA 2.5 ports: two on-board vertical latching connectors, one port to the mSATA port
- Four serial ports: RS-232/422/485
- Flash interfaces: eUSB, PCIe Mini Card/mSATA SSD, CompactFlash
- RoHS-compliant
- Extended temperature options
- Integrated high performance video with simultaneous, independent analog and FPD output capability
 - Intel 3rd generation graphics core
 - 24-bit VGA up to 2048x1536
 - 18-bit LVDS up to 1366x768
- SPX interface supports up to four external SPI devices either of user design or any of the SPX™ series of expansion boards, with clock frequencies from 1-8 MHz
- Two 16-bit counter/timers (standard); three 8254 Programmable Interval Timers (custom)
- TVS devices for ESD protection
- Watchdog timer
- Field upgradeable UEFI BIOS with OEM enhancements
- Customization available

The Iguana is compatible with popular operating systems such as Windows CE, Windows XP Professional/XP Embedded (SP3), Linux, VxWorks, and QNX (see the [VersaLogic OS Compatibility Chart](#)). Note: Windows 7 will not install with less than 512 MB RAM.

The Iguana features high reliability design and construction, including voltage sensing reset circuits and self-resetting fuses on the power supplies to the user I/O connectors.

Iguana boards are subjected to 100% functional testing and are backed by a limited two-year warranty. Careful parts sourcing and US-based technical support ensure the highest possible quality, reliability, service, and product longevity for this exceptional SBC.

Technical Specifications

Specifications are typical at 25°C with +5V supply unless otherwise noted. Specifications are subject to change without notification.

Board Size:

4.5" x 6.5" (EPIC standard)

Storage Temperature:

-40° to +85°C

Operating Temperature:

VL-EPIC-25SA, SB, with heatsink: 0° to +60°C
VL-EPIC-25EA, RA¹, RB¹ EPIC-25EAR with fan, heatsink: -40° to +85°C

Power Requirements: at +25°C with +5V supply running Windows XP with 2 GB RAM, LVDS display, SATA, GbE, and USB keyboard/mouse

VL-EPIC-25SA: 1.68A (8.40W) idle, 1.82A (9.1W) typical, 1.94A (9.7W) max.

VL-EPIC-25SB: 2.08A (10.40W) idle, 2.34A (11.7W) typical, 2.58A (12.9W) max

VL-EPIC-25EA/EPIC-25EAR², RA: 1.88A (9.40W) idle, 2.02A (10.1W) typical, 2.14A (10.7W) max.

VL-EPIC-25RB/EPIC-25EAR: 2.28A (11.4W) idle, 2.54A (12.7W) typical, 2.78A (13.9W) max.

+3.3V or ±12V may be required by some expansion modules

System Reset:

Input power sensing, resets below 4.70V typ. Watchdog timeout (warm/cold reset)

DRAM:

One SO-DIMM socket, up to 2GB of DDR3 DRAM

Video Interface:

Intel 3rd generation graphic core, 400 MHz
18-bit LVDS interface
VGA – 2048x1536 with 24-bit color
LVDS – 1355x768 with 18-bit color

SATA Interface:

Three SATA 2.5 ports: two on-board vertical latching connectors, one port to the mSATA port

Flash Storage:

eUSB site
PCIe Mini Card/mSATA site
CompactFlash socket

Ethernet Interface:

Two Intel 82574IT based 10BaseT / 100BaseTX / 1000BaseT Ethernet Controllers

USB:

Eight host USB channels: two on-board Type A connectors, four Type A connectors on VL-CBR-5013 paddleboard, one on Mini PCIe connector, 1 on eUSB header

1. Special order. Ruggedized Ethernet and user I/O connectors.

2. EPIC-25EAR is conformal coated.

Serial Ports 0-1:

RS-232/422/485, 16C550 compatible, 460 Kbps max., 4-wire RS-232 (CTS and RTS handshaking), DB-9 connector on VL-CBR-5013 paddleboard

Serial Ports 2-3:

RS-232/422/485, 16C550 compatible, 460 Kbps max., 4-wire RS-232 (CTS and RTS handshaking), terminal block on VL-CBR-5013 paddleboard

Analog Input:

8-channel, 12-bit, single-ended, 100 Ksps, channel independent input range: bipolar ±5, ±10, or unipolar 0 to +5V or 0 to +10V

Analog Output:

4-channel, 12-bit, single-ended, 100 Ksps
0V to 4.096V

Digital Interface:

16-channel, ±24 mA outputs, 3.3V signaling

SPX:

Supports four external SPI chips of user design or any SPX series expansion board

Audio:

Stereo HD audio line in/out

BIOS:

AMI UEFI BIOS with OEM enhancements, field programmable.

Bus Speed:

PC/104-Plus (PCI): 33.33 MHz
PC/104 (ISA): 8.33 MHz

Compatibility:

PC/104 - Full compliance

Weight:

VL-EPIC-25SA - 0.645 lbs (0.293 kg)
VL-EPIC-25SB - 0.662 lbs (0.300 kg)
VL-EPIC-25EA - 0.701 lbs (0.318 kg)
VL-EPIC-25EAR - 0.701 lbs (0.318 kg)

Block Diagram

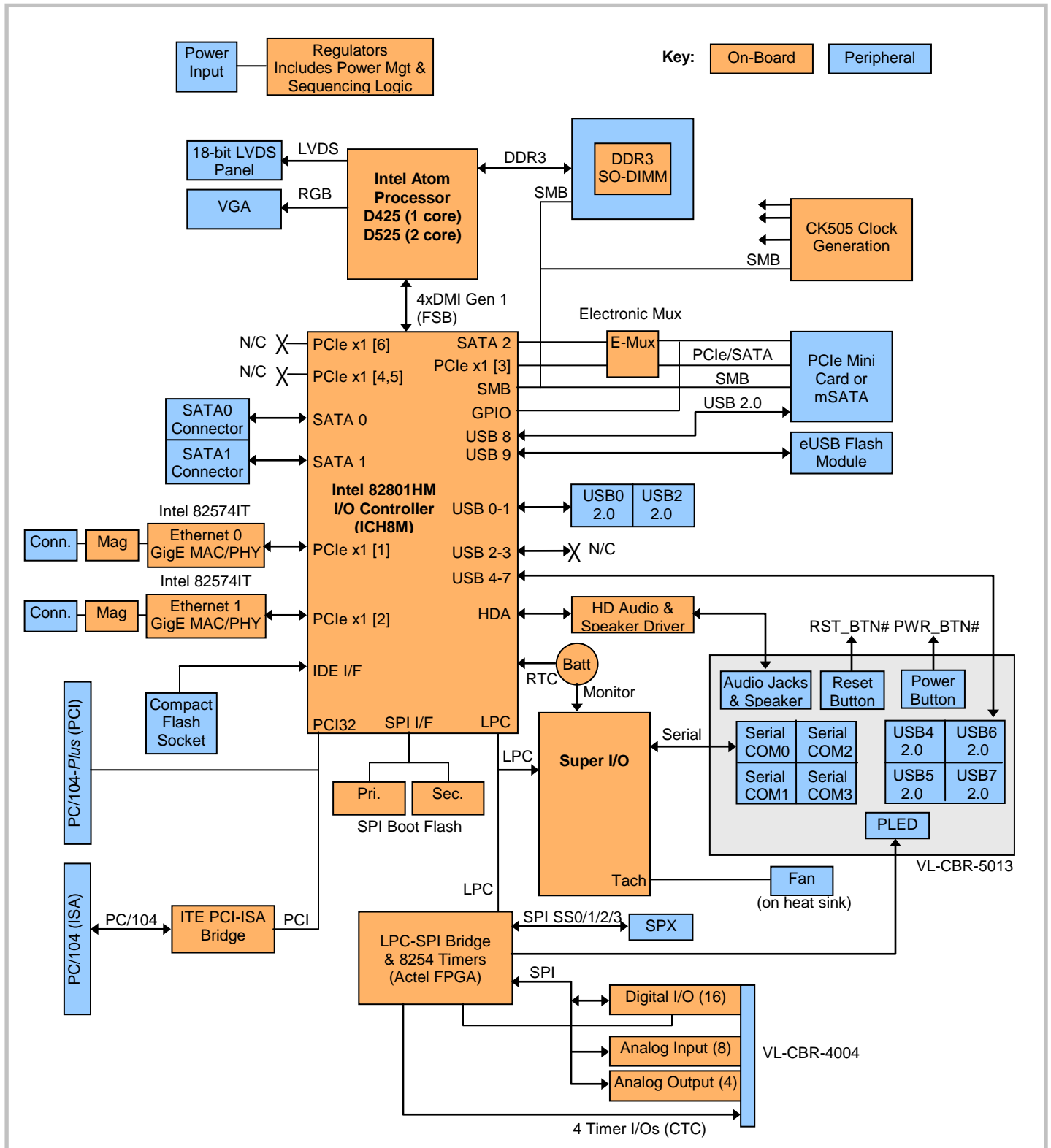

Thermal Considerations

CPU DIE TEMPERATURE

The CPU die temperature is affected by numerous conditions, such as CPU utilization, CPU speed, ambient air temperature, air flow, thermal effects of adjacent circuit boards, external heat sources, and many others.

The CPU is protected from over-temperature conditions by two mechanisms.

The CPU will automatically slow down by 50% whenever its die temperature exceeds +100°C. When the temperature falls back below +100°C, the CPU resumes full-speed operation.

As a failsafe, if the CPU die temperature climbs above +105°C, the CPU will turn itself off to prevent damage to the chip.

MODEL DIFFERENCES

VersaLogic offers both commercial and industrial temperature models of the VL-EPIC-25. The basic operating temperature specification for both models is shown below.

- VL-EPIC-25SA and SB: 0°C to +60°C free air, no airflow, heatsink, no fan
- VL-EPIC-25EA/ EPIC-25EAR, RA, and RB: -40°C to +85°C free air, heatsink, fan

RoHS Compliance

The Iguana is RoHS-compliant.

ABOUT ROHS

In 2003, the European Union issued Directive 2002/95/EC regarding the Restriction of the use of certain Hazardous Substances (RoHS) in electrical and electronic equipment.

The RoHS directive requires producers of electrical and electronic equipment to reduce to acceptable levels the presence of six environmentally sensitive substances: lead, mercury, cadmium, hexavalent chromium, and the presence of polybrominated biphenyls (PBB) and polybrominated diphenyl ethers (PBDE) flame retardants, in certain electrical and electronic products sold in the European Union (EU) beginning July 1, 2006.

VersaLogic Corp. is committed to supporting customers with high-quality products and services meeting the European Union's RoHS directive.

Warnings

ELECTROSTATIC DISCHARGE

Warning! Electrostatic discharge (ESD) can damage circuit boards, disk drives, and other components. The circuit board must only be handled at an ESD workstation. If an approved station is not available, some measure of protection can be provided by wearing a grounded antistatic wrist strap. Keep all plastic away from the board, and do not slide the board over any surface.

After removing the board from its protective wrapper, place the board on a grounded, static-free surface, component side up. Use an antistatic foam pad if available.

The board should also be protected inside a closed metallic antistatic envelope during shipment or storage.

Note: The exterior coating on some metallic antistatic bags is sufficiently conductive to cause excessive battery drain if the bag comes in contact with the bottom side of the Iguana.

LITHIUM BATTERY

Warning! To prevent shorting, premature failure, or damage to the lithium battery, do not place the board on a conductive surface such as metal, black conductive foam, or the outside surface of a metalized ESD protective pouch. The lithium battery may explode if mistreated. Do not recharge, disassemble, or dispose of in fire. Dispose of used batteries promptly and in an environmentally suitable manner.

HANDLING CARE

Warning! Care must be taken when handling the board not to touch the exposed circuitry with your fingers. Though it will not damage the circuitry, it is possible that small amounts of oil or perspiration on the skin could have enough conductivity to cause the Real Time Clock to become corrupted through careless handling.

Technical Support

If you are unable to solve a problem after reading this manual, please visit the Iguana product support Web page below. The support page provides links to component datasheets, device drivers, and BIOS and PLD code updates.

[Iguana Support Page](http://www.versalogic.com/private/iguanasupport.asp)

<http://www.versalogic.com/private/iguanasupport.asp>

The VersaTech KnowledgeBase contains a wealth of technical information about VersaLogic products, along with product advisories. Click the link below to see all KnowledgeBase articles related to the VL-EPIC-25.

[VersaTech KnowledgeBase](#)

If you have further questions, contact VersaLogic Technical Support at (503) 747-2261. VersaLogic support engineers are also available via e-mail at Support@VersaLogic.com.

REPAIR SERVICE

If your product requires service, you must obtain a Returned Material Authorization (RMA) number by calling (503) 747-2261.

Please provide the following information:

- Your name, the name of your company, your phone number, and e-mail address
- The name of a technician or engineer that can be contacted if any questions arise
- Quantity of items being returned
- The model and serial number (barcode) of each item
- A detailed description of the problem
- Steps you have taken to resolve or recreate the problem
- The return shipping address

Warranty Repair

All parts and labor charges are covered, including return shipping charges for UPS Ground delivery to United States addresses.

Non-warranty Repair All approved non-warranty repairs are subject to diagnosis and labor charges, parts charges, and return shipping fees. Please specify the shipping method you prefer and provide a purchase order number for invoicing the repair.

Note: Please mark the RMA number clearly on the outside of the box before returning.

Initial Configuration

The following components are recommended for a typical development system with the Iguana:

- ATX power supply
- DDR3 DRAM module
- USB keyboard and mouse
- SATA hard drive
- USB CD-ROM drive
- LVDS or VGA display

The following VersaLogic cables are recommended:

- VL-CBR-2022 – Power adapter cable
- VL-CBR-5013 – Paddleboard
- VL-CBR-0701 – SATA data cable
- LVDS or VGA video adapter cable

You will also need an operating system (OS) installation CD-ROM.

Basic Setup

The following steps outline the procedure for setting up a typical development system. The Iguana should be handled at an ESD workstation or while wearing a grounded antistatic wrist strap.

Before you begin, unpack the Iguana and accessories. Verify that you received all the items you ordered. Inspect the system visually for any damage that may have occurred in shipping. Contact Support@VersaLogic.com immediately if any items are damaged or missing.

Gather all the peripheral devices you plan to attach to the Iguana and their interface and power cables.

It is recommended that you attach standoffs to the board (see Hardware Assembly) to stabilize the board and make it easier to work with.

Figure 1 shows a typical start-up configuration.

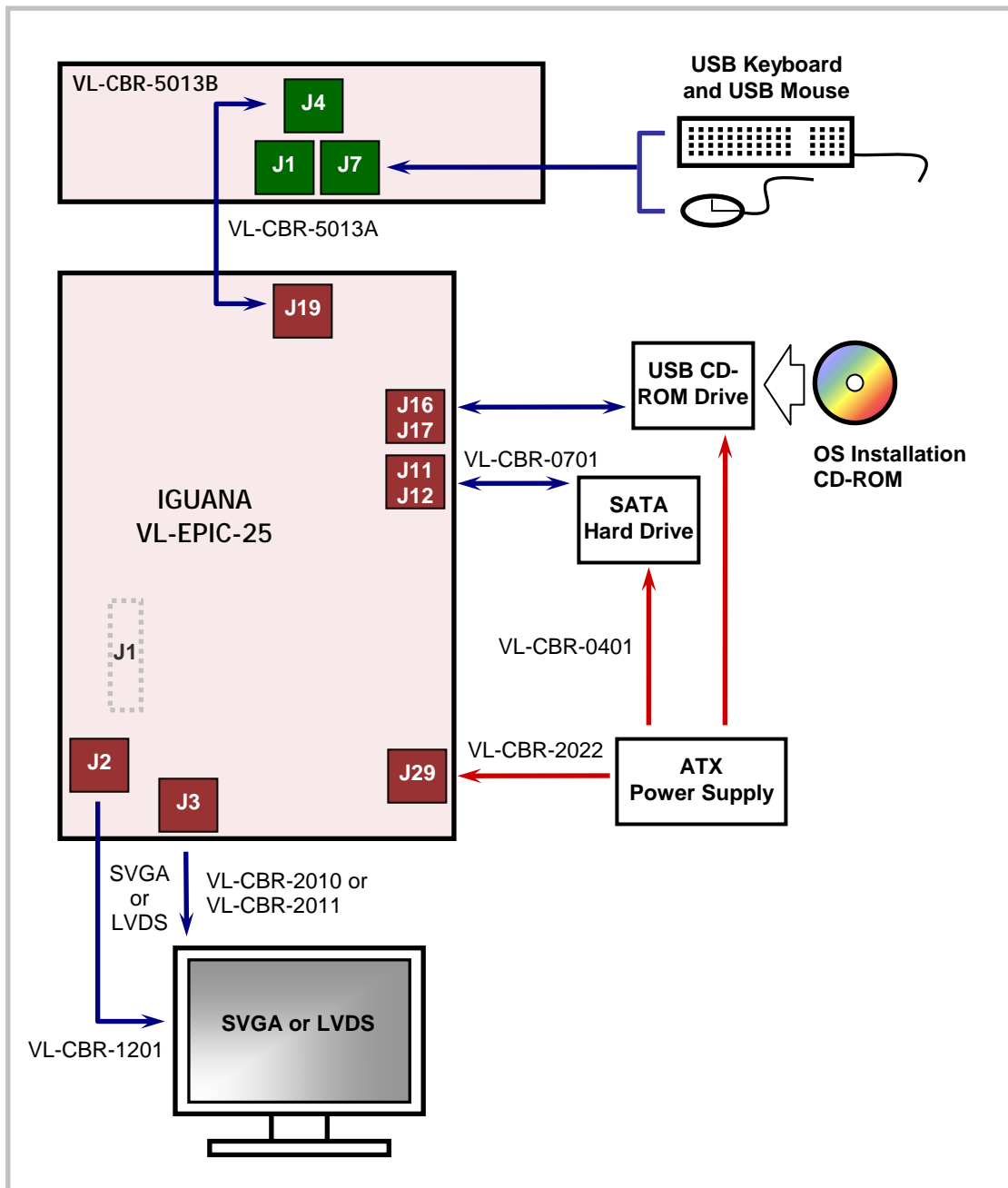

Figure 1. Typical Start-up Configuration

1. Install Memory

- Insert a DDR3 DRAM module into SO-DIMM socket J1 on the bottom of the board and latch it into place.

2. Attach Cables and Peripherals

- Plug the appropriate video cable into the LVDS connector (J3) or the VGA connector (J2) and attach the monitor.

- Plug the VL-CBR-5013A cable into the user I/O connector (J19) on the Iguana and the VL-CBR-5013B paddleboard (the cable is shipped attached to the paddleboard).
- Plug a USB keyboard and mouse into USB sockets J1 or J7 of the paddleboard.
- Plug the SATA data cable VL-CBR-0701 into socket J11 or J12. Attach a hard drive to the cable.
- Attach the ATX SATA power cable (VL-CBR-0401) to the ATX power supply and the SATA hard drive.
- Plug a USB CD-ROM drive into a USB socket J16 or J17.
- Attach an ATX power cable to any 3.5" drive that is not already attached to the power supply (hard drive or CD-ROM drive).

3. Attach Power

- Plug the power adapter cable VL-CBR-2022 into socket J29. Attach the motherboard connector of the ATX power supply to the adapter.

4. Review Configuration

- Before you power up the system, double check all the connections. Make sure all cables are oriented correctly and that adequate power will be supplied to the Iguana and peripheral devices.

5. Power On

- Turn on the ATX power supply and the video monitor. If the system is correctly configured, a video signal should be present. (There might be a delay of several seconds before the video signal becomes present.) If video does not appear, press the Power Button on the paddleboard.

6. Install Operating System

- Install the OS according to the instructions provided by the OS manufacturer.

Note: If you intend to operate the Iguana under Windows XP or Windows XP Embedded, be sure to use Service Pack 3 (SP3) for full support of the latest device features.

Operating System Installation

The standard PC architecture used on the Iguana makes the installation and use of most of the standard x86-based operating systems very simple. The operating systems listed on the [VersaLogic OS Compatibility Chart](#) use the standard installation procedures provided by the maker of the OS. Special optimized hardware drivers for a particular OS, or a link to the drivers, are available at the [Iguana Product Support web page](#).

BIOS Setup Screens

See KnowledgeBase article [VT1701 - BIOS Setup Reference](#) for complete information on how to configure the Iguana BIOS.

Dimensions and Mounting

IGUANA DIMENSIONS

The VL-EPIC-25 complies with EPIC dimensional standards. Dimensions are given below to help with pre-production planning and layout.

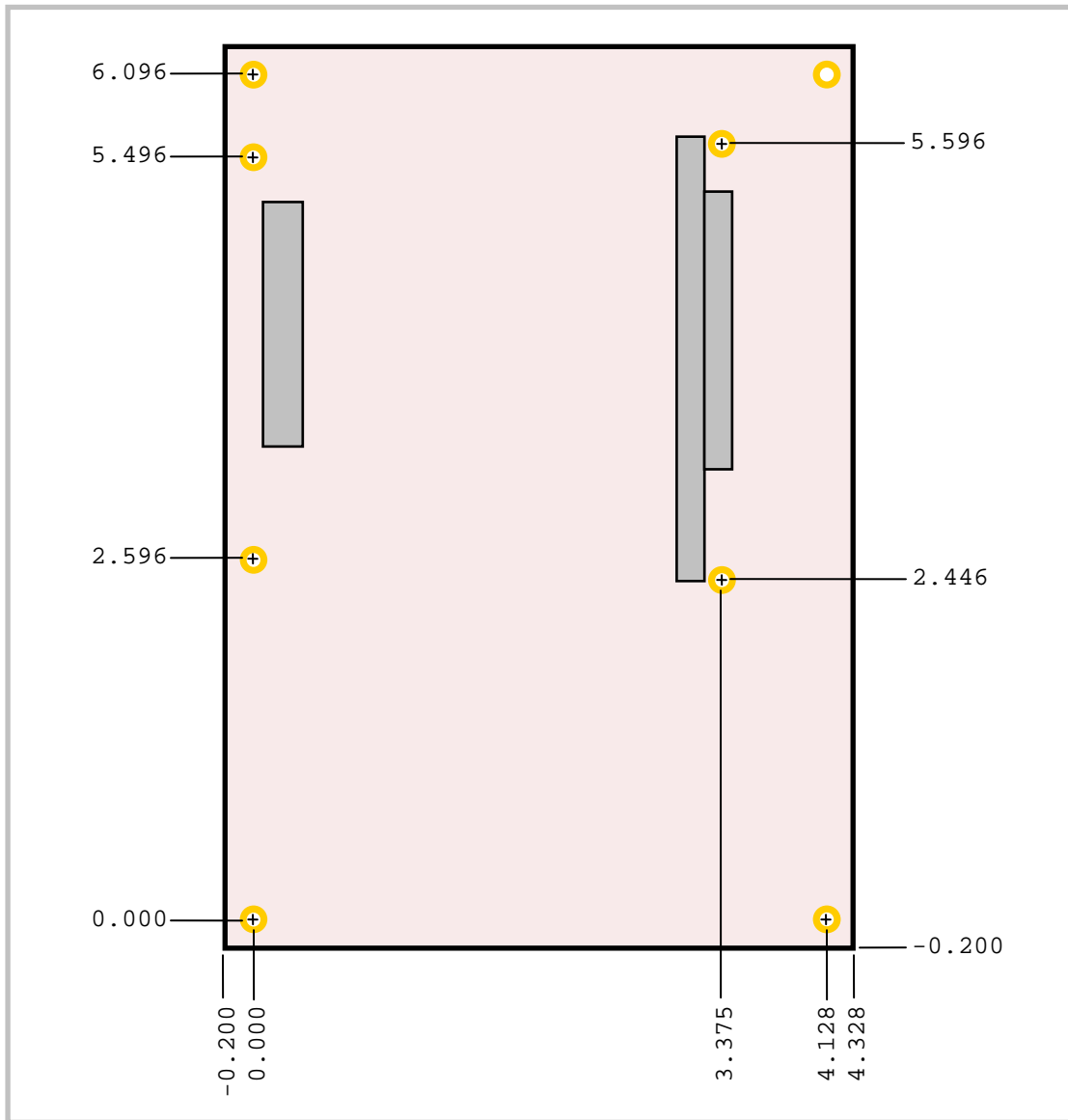

Figure 2. Iguana Dimensions and Mounting Holes

(Not to scale. All dimensions in inches.)

VL-CBR-5013 DIMENSIONS

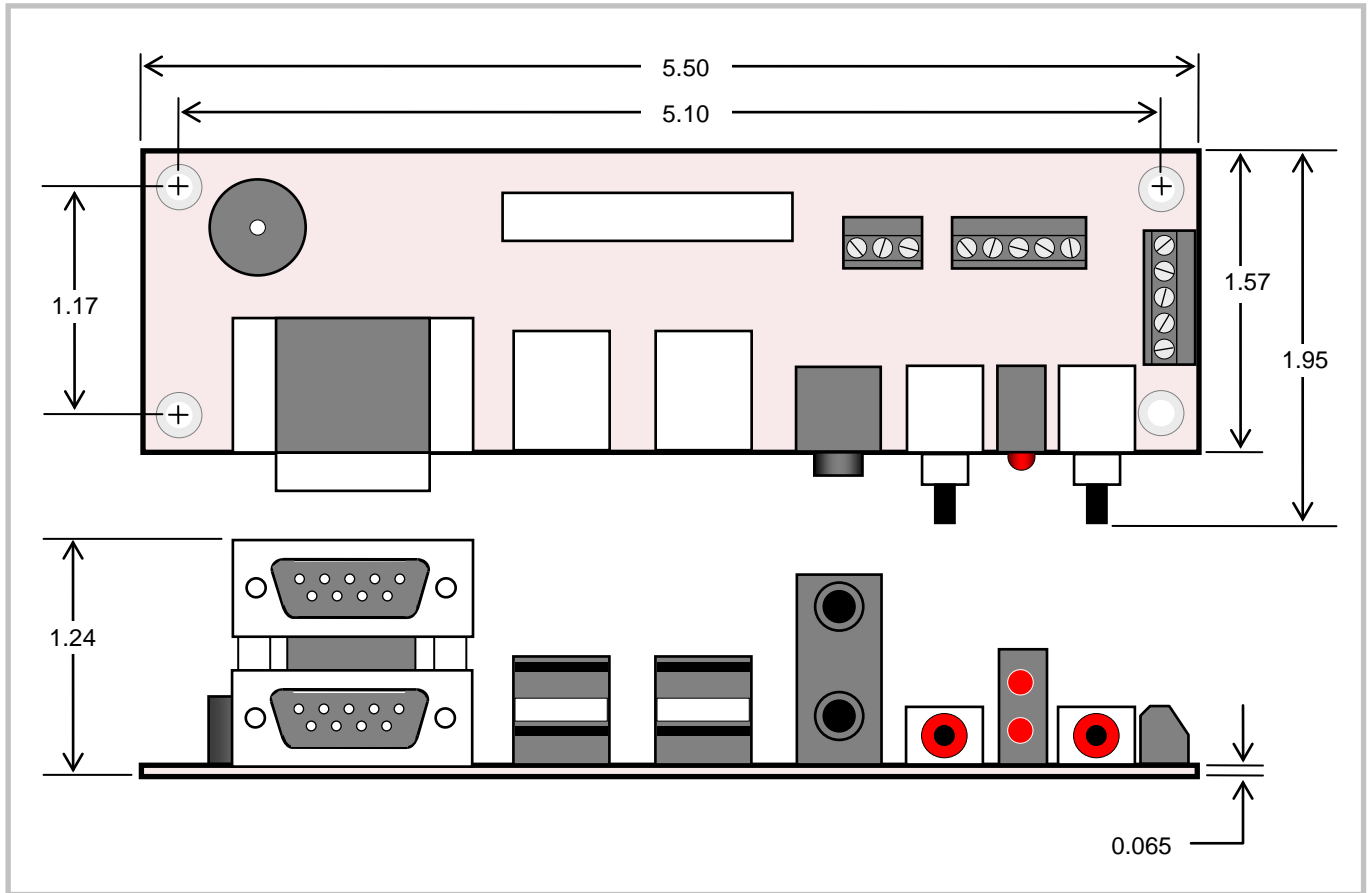

Figure 3. VL-CBR-5013 Dimensions and Mounting Holes
(Not to scale. All dimensions in inches.)

VL-CBR-4004 DIMENSIONS

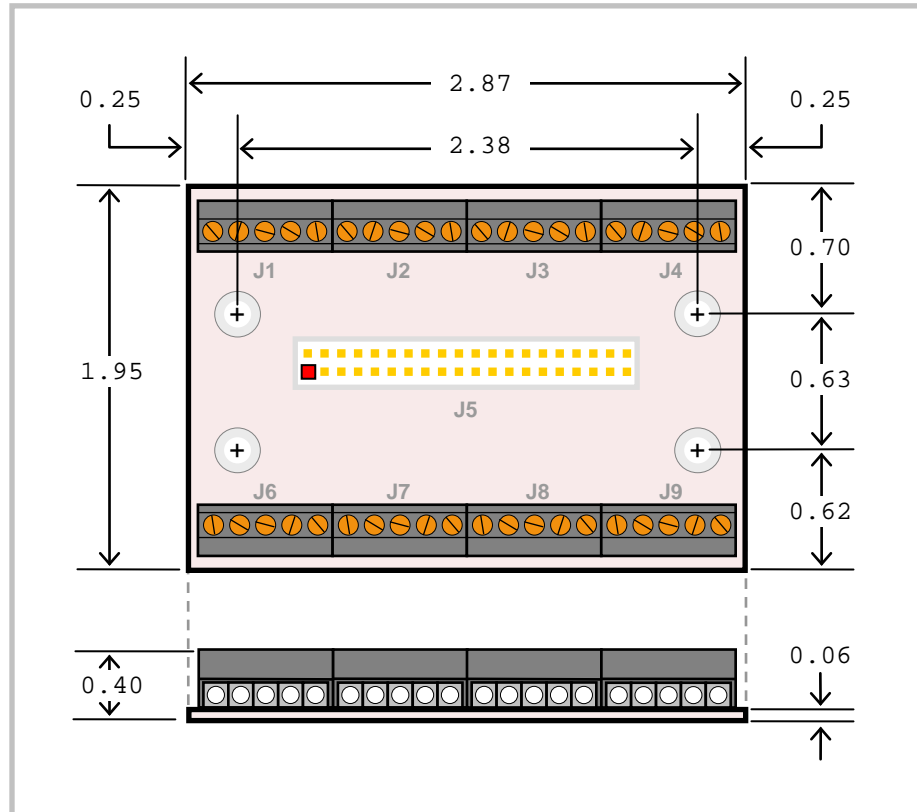

Figure 4. VL-CBR-4004 Dimensions and Mounting Holes
(Not to scale. All dimensions in inches.)

HARDWARE ASSEMBLY

The Iguana uses PC/104 and PC/104-Plus connectors so that expansion modules can be added to the top of the stack. PC/104 (ISA) modules must not be positioned between the Iguana and any PC/104-Plus (PCI) modules on the stack.

The entire assembly can sit on a table top or be secured to a base plate. When bolting the unit down, make sure to secure all eight standoffs (A and B) to the mounting surface to prevent circuit board flexing. Four standoffs (B) must be used under the stack. These are secured with four male-female standoffs (C), threaded from the top side, which also serve as mounting struts for the PC/104 stack. Standoffs are secured to the top circuit board using pan head screws. Four standoffs and screws are available as part number VL-HDW-106.

Note: A minimum height clearance of 8.5mm is required beneath the board to avoid contacting the tallest component (the CompactFlash socket) with the enclosure or other components.

An extractor tool is available (part number VL-HDW-203) to separate the PC/104 modules from the stack. Use caution when using the extractor tool not to damage any board components.

STANDOFF LOCATIONS

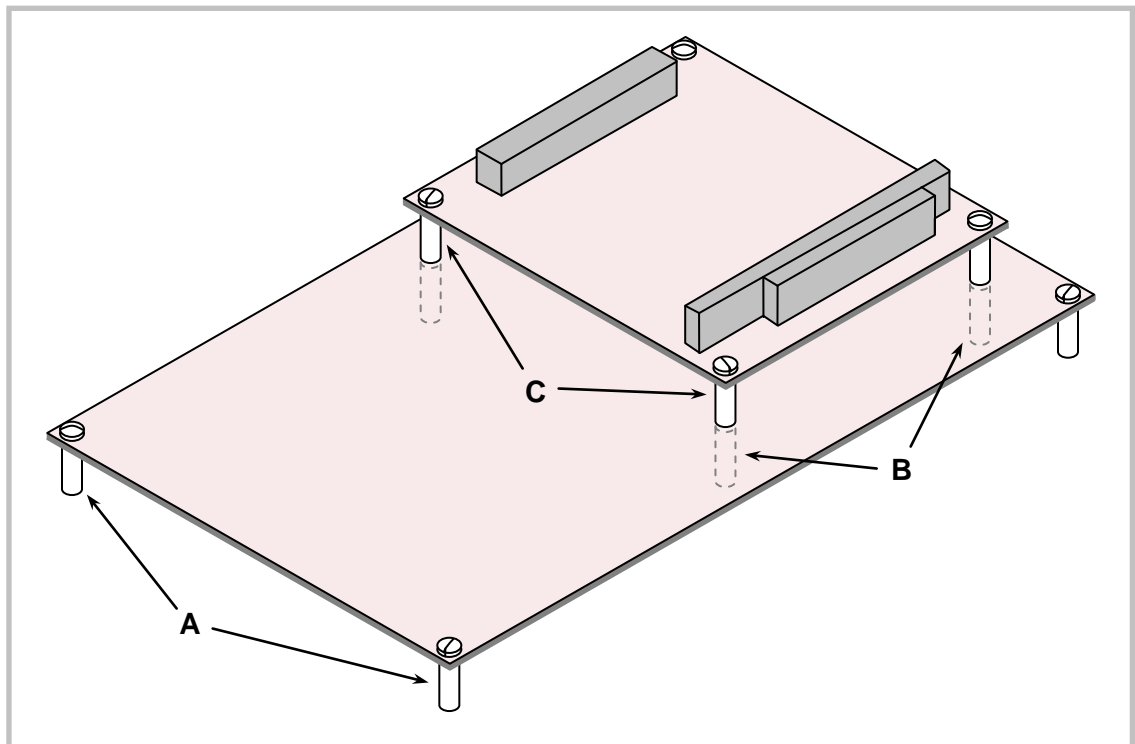

Figure 5. Stack Arrangement Example

External Connectors

IGUANA CONNECTOR LOCATIONS – TOP

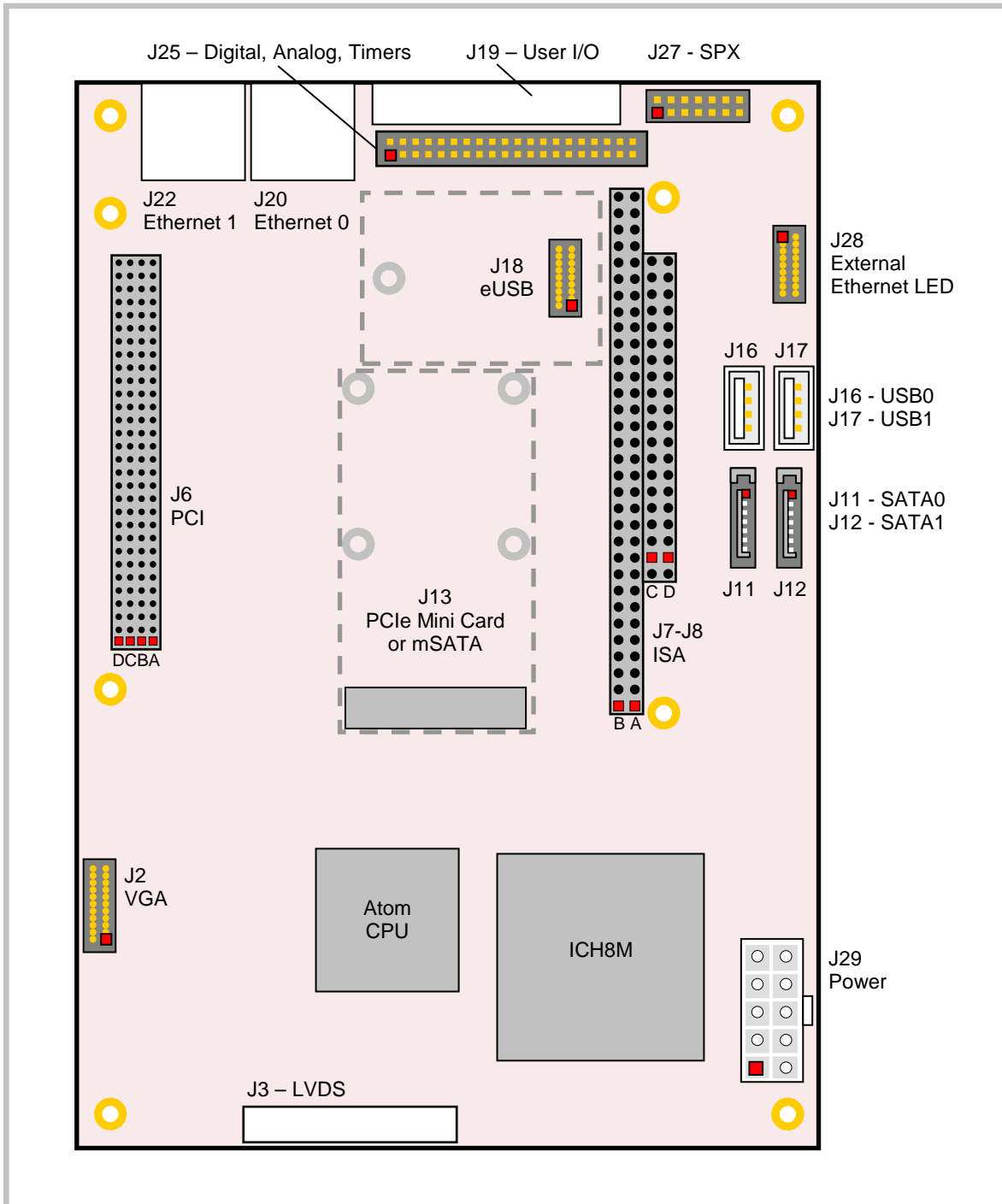

Figure 6. Connector Locations (Top)

IGUANA CONNECTOR LOCATIONS – BOTTOM

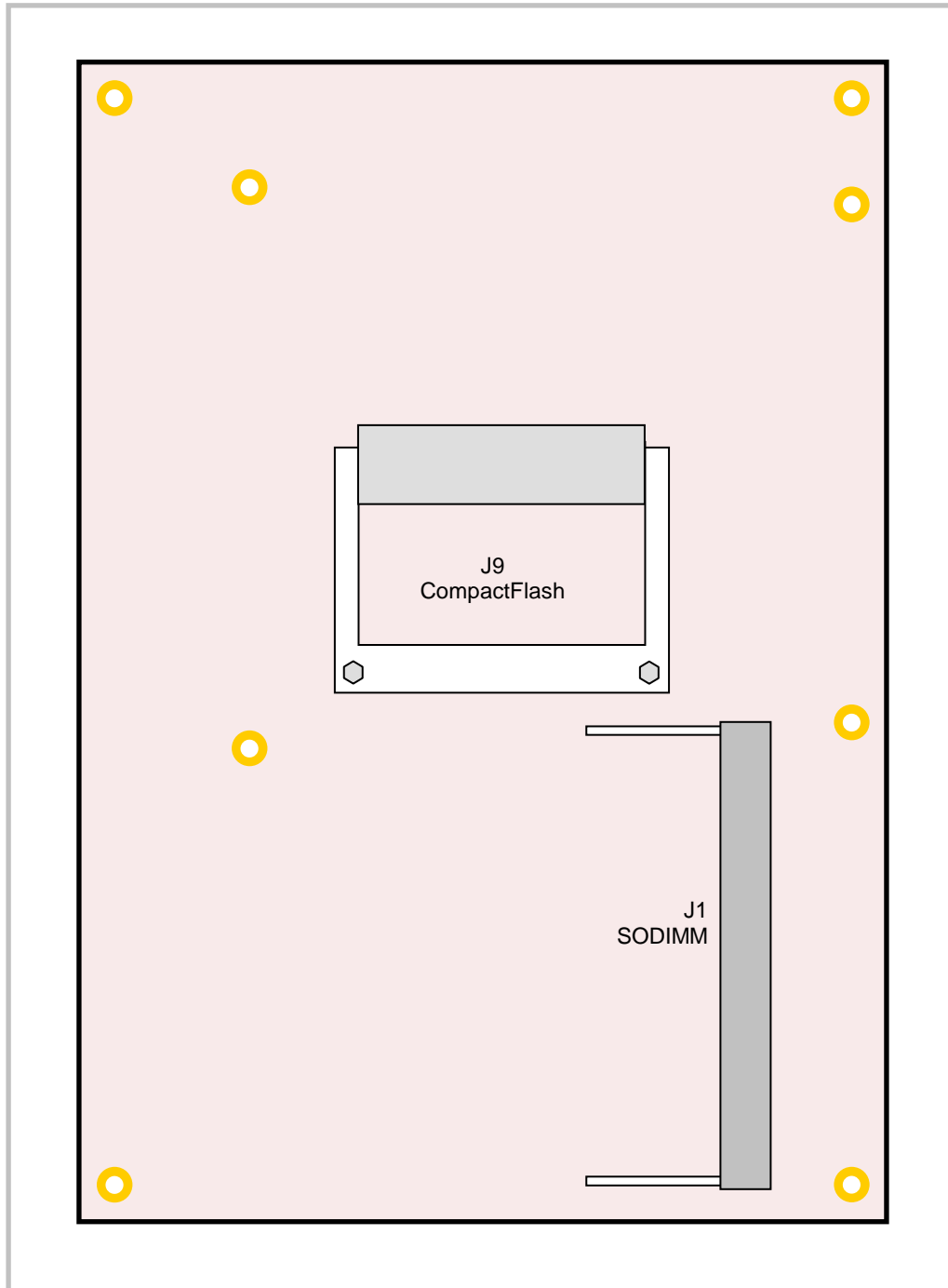

Figure 7. Connector Locations (Bottom)

IGUANA CONNECTOR FUNCTIONS AND INTERFACE CABLES

Table 1 provides information about the function, mating connectors, and transition cables for Iguana connectors. Page numbers indicate where a detailed pinout or further information is available.

Table 1: Connector Functions and Interface Cables

Connector ¹	Function	Mating Connector	Transition Cable	Cable Description	Page	Pin 1 Location X Coord. Y Coord. ²	
J1	204-pin SO-DIMM 1.5V DDR3 Socket	(DDR3 RAM)	—	—	25	0.656	1.226
J2	SVGA Video Output	FCI 89361-712LF or FCI 89947-712LF	VL-CBR-1201	12" 12-pin 2 mm IDC to 15-pin HD D-Sub VGA	36	-0.033	1.079
J3	LVDS	20-pin, PanelMate 1.25mm	VL-CBR-2010; VL-CBR-2011; VL-CBR-2012 (24-bit)	18-bit TFT FPD using 20-pin Hirose 18-bit TFT FPD using 20-pin JAE	37	1.399	-0.081
J6	PCI	AMP 1375799-1	—	—	27	0.236	2.896
J7, J8	ISA	AMP 1375795-2	—	—	27	3.175 ³	2.496
J9	CompactFlash Type I & II	—	—	—	33	2.009	2.736
J11	SATA	Standard SATA	VL-CBR-0701; VL-CBR-0401	500 mm (19.75") 7-pin, straight-to-straight SATA data; ATX to SATA power adapter	30	3.793	3.793
J12	SATA	Standard SATA	VL-CBR-0701; VL-CBR-0401	500 mm (19.75") 7-pin, straight-to-straight SATA data; ATX to SATA power adapter	30	4.187	3.793
J13	PCIe Mini Card mSATA	—	—	—	33	1.514	2.533
J16	USB 1	Standard USB Type A	—	—	32	3.805	4.120
J17	USB 2	Standard USB Type A	—	—	32	4.128	4.120
J18	eUSB Flash Drive	—	—	—	33	2.809	5.102
J19	COM ports, USB, PLED, power LED, push-button reset, power button, audio jacks, PC speaker	Oupiin 1204-50G00B2A	VL-CBR-5013A	18" 1.27 mm IDC 50-pin to 50-pin	39	2.371	6.176
J20	Ethernet 0	RJ45	—	—	29	1.060	6.024
J22	Ethernet 1	RJ45	—	—	29	0.362	6.024
J25	Digital I/O, Analog I/O, Timer I/O	FCI 89361-340LF	VL-CBR-4004	12" 2 mm 40-pin to 40-pin IDC to VL-CBR-4004 board	42, 47, 49, 50	1.722	5.831
J26	Fan (model AE)	—	—	—	—	4.175	1.176
J27	SPX	FCI 89361-714LF	VL-CBR-1401 or VL-CBR-1402	2mm 14-pin IDC, 2 or 4 SPX device cable	51	3.364	6.126
J28	External Ethernet LED	—	—	—	30	4.159	5.295
J29	Main power input	Molex 39-01-2100 Molex 39-00-0059 (10ea.)	VL-CBR-2022	6" ATX to EPIC power cable	22	3.946	0.289

1. Connectors J4, J5 (XDP Debug), J10 (SPI Programming), J14, J15, J21 & J23 (ruggedized Ethernet), J24 (JTAG), J26 are either not assigned, not installed, or for factory use only.

2. The PCB Origin is the mounting hole to the lower left as shown in Figure 3. Coordinates in inches.

3. Pin A1.

VL-CBR-5013 CONNECTOR LOCATIONS

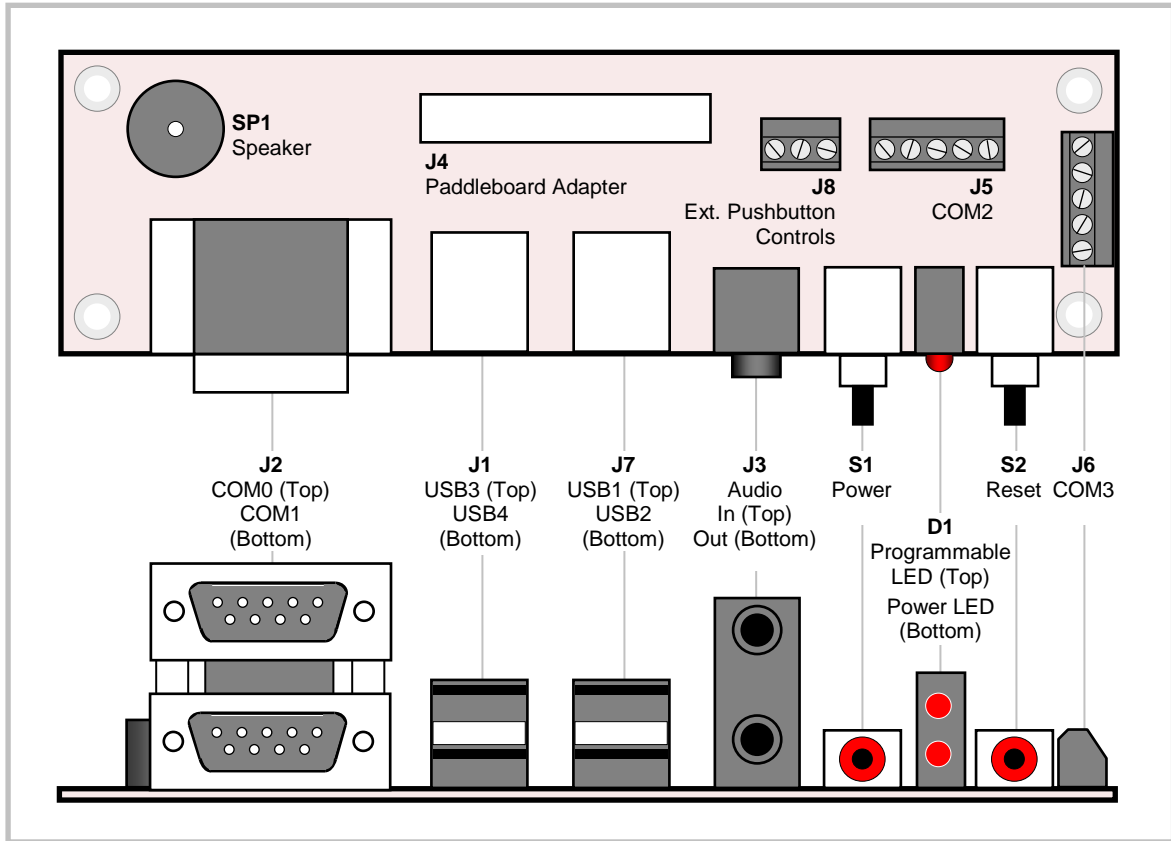

Figure 8. VL-CBR-5013 Connector Locations

VL-CBR-5013 CONNECTOR FUNCTIONS

Table 2: VL-CBR-5013 Connector Functions and Interface Cables

Connector	Function	PCB Connector	Description
J1	USB3, USB4	USB Type A	USB Host
J2	COM0, COM1	Kycon K42-E9P/P-A4N	Dual DB-9 male
J3	Audio In/Out	3.5 mm dual audio jack	–
J4	High Density Connector	FCI 20021511-00050T1LF Oupiin 3216-A50G00SBA Samtec SHF-125-01-F-D-TH	1.27 mm, 50-pin, keyed header
J5	COM2	Conta-Clip 10250.4	5-pin screw terminal
J6	COM3	Conta-Clip 10250.4	5-pin screw terminal
J7	USB1, USB2	USB Type A	USB Host
J8	External Reset and Power Buttons	Conta-Clip 10250.4	3-pin screw terminal
D1	PLED (Top), Power LED (Bottom)	LED	–
S1	Power Button	Pushbutton	–
S2	Reset Button	Pushbutton	–
SP1	Speaker	Piezo speaker	–

VL-CBR-4004 CONNECTOR LOCATIONS

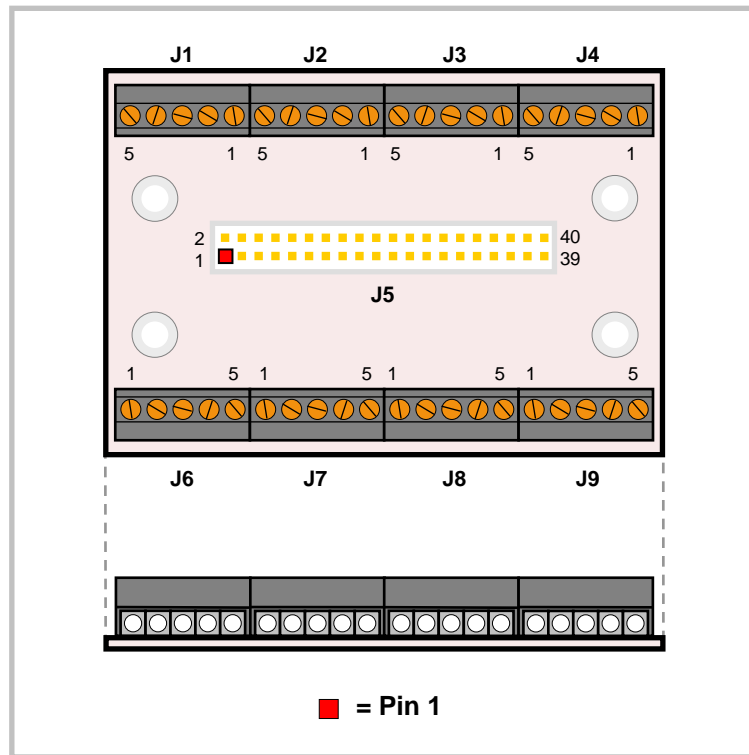

Figure 9. VL-CBR-4004 Connectors

Jumper Blocks

JUMPERS AS-SHIPED CONFIGURATION

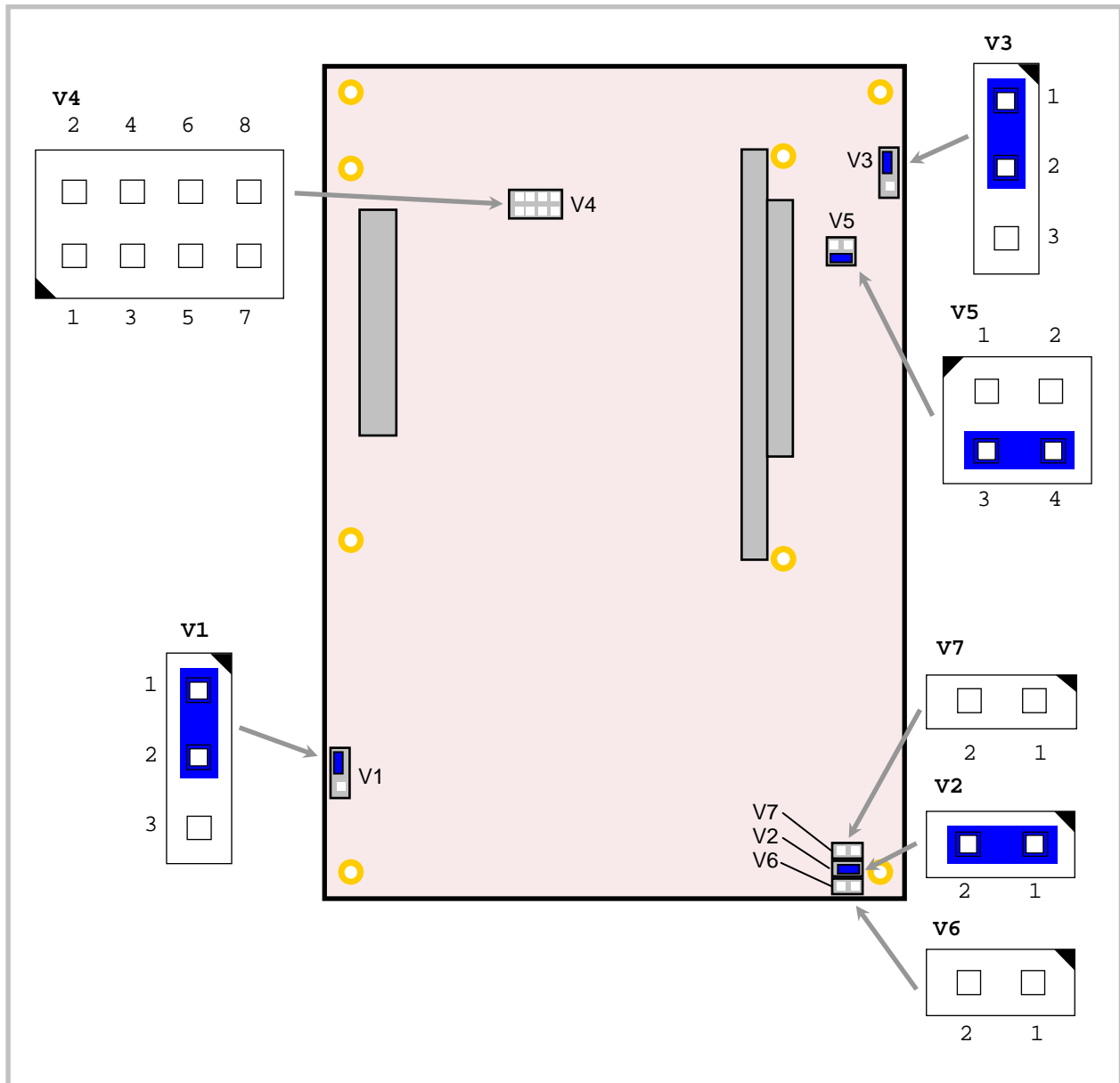

Figure 10. Jumper Block Locations

JUMPER SUMMARY

Table 3: Jumper Summary

Jumper Block	Description	As Shipped	Page
V1[1-2-3]	Factory Use Only. Jumper may be installed or removed.	V1[1-2] In	—
V2[1-2]	SPI Flash Write-Protect In – Writable Out – Write Protected	In	33
V3[1-2-3]	Real-Time Clock (RTC) Reset [1-2] In – Normal operation (jumper storage) [2-3] In – Reset RTC	[1-2] In	25
V4[1-2]	COM0 configuration In — RS-485 (Rx endpoint termination) Out — RS-232	Out	31
V4[3-4]	COM1 configuration In — RS-485 (Rx endpoint termination) Out — RS-232	Out	31
V4[5-6]	COM2 configuration In — RS-485 (Rx endpoint termination) Out — RS-232	Out	31
V4[7-8]	COM3 configuration In — RS-485 (Rx endpoint termination) Out — RS-232	Out	31
V5[1-2]	BIOS Select In — Secondary BIOS Out — Primary BIOS	Out	59
V5[3-4]	General Purpose Input Bit 1 In — Bit D7 in GPI register reads as 1 Out — Bit D7 in GPI register reads as 0	In	59
V6[1-2]	Clear Non-volatile RAM (NVRAM) In — Resets BIOS settings to factory defaults. Out — Normal	Out	25
V7[1-2]	Factory Use Only — Jumper must not be installed.	Out	—

Power Supply

POWER CONNECTORS

Main power is applied to the Iguana through an EPIC-style 10-pin polarized connector at location J29.

Warning! To prevent severe and possibly irreparable damage to the system, it is critical that the power connectors are wired correctly. Make sure to use both +5VDC pins and all ground pins to prevent excess voltage drop.

Table 4: Main Power Connector Pinout

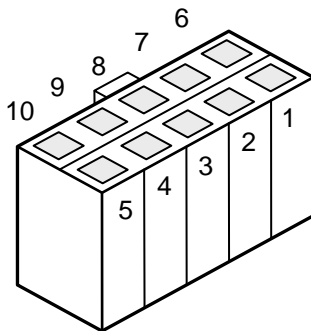

J29 Pin	Signal Name	Description
1*	GND	Ground
2	GND	Ground
3	GND	Ground
4	+12VDC	Power Input
5	+3.3VDC	Power Input
6**	NC	Not connected
7	+5VDC	Power Input
8	+5VDC	Power Input
9	-12VDC	Power Input
10	GND	Ground

* Pin 1 is typically used in EPIC-style power cables as a PS-ON signal. Since the EBX-11 does not support soft-off, pin 1 is internally connected to ground.

** Pin 6 is typically used in EPIC style power cables as a 5VSB (5V Stand By) signal. Since the EBX-11 does not support soft-off, pin 6 is an internal no connect.

Note: The +3.3 VDC, +12 VDC and -12 VDC inputs are necessary for expansion modules that require these voltages.

POWER REQUIREMENTS

The Iguana requires only +5V ($\pm 5\%$) for proper operation. (Initial power up typically requires $> +4.85V$ due to 0.1V of input voltage monitoring hysteresis.) The higher voltages required for the RS-232 ports and analog inputs are generated as needed on-board. Variable low-voltage supply circuits provide the many power rails required by the CPU and other on-board devices.

The exact power requirement of the Iguana depends on several factors, including memory configuration, CPU speed, peripheral connections, type and number of expansion modules and attached devices. For example, driving long RS-232 lines at high speed can increase power demand, and supplying 4.85V input voltage would meet the load requirements for on-board USB ports, but 5V would be needed to meet the load requirements on the VL-CBR-5013 USB ports.

POWER DELIVERY CONSIDERATIONS

Using the VersaLogic approved power supply (VL-PS200-ATX) and power cable (VL-CBR-2022) will ensure high quality power delivery to the board. Customers who design their own power delivery methods should take into consideration the guidelines below to ensure good power connections.

Also, the specifications for typical operating current do not include any off-board power usage that may be fed through the VL-EPIC-25 power connector. Expansion boards and USB devices plugged into the board will source additional power through the VL-EPIC-25 power connector.

- Do not use wire smaller than 18 AWG. Use high quality UL 1007 compliant stranded wire.
- The length of the wire should not exceed 18".
- Avoid using any additional connectors in the power delivery system.
- The power and ground leads should be twisted together, or as close together as possible to reduce lead inductance.
- A separate conductor must be used for each of the power pins.
- All power input pins and all ground pins must be independently connected between the power source and the power connector.
- Implement the remote sense feature on your power supply if it has one. Connect the remote sense lines in tandem with one of the power input and ground pins. This is done at the connector to compensate for losses in the power wires.

Use a high quality power supply that can supply a stable voltage while reacting to widely varying current draws.

LITHIUM BATTERY

Warning! To prevent shorting, premature failure, or damage to the lithium battery, do not place the board on a conductive surface such as metal, black conductive foam, or the outside surface of a metalized ESD protective pouch. The lithium battery may explode if mistreated. Do not recharge, disassemble or dispose of in fire. Dispose of used batteries promptly.

Normal battery voltage should be at least +3V. If the voltage drops below +2V, contact the factory for a replacement (part number HB3/0-1). The life expectancy under normal use is approximately 10 years. Battery voltage can be monitored on the [H/W Monitor BIOS setup screen](#).

Storage temperature affects the life of the battery. The on-board Real-Time Clock (RTC) continues to draw power even when the Iguana is powered off. The following graph shows that battery life improves when the board is stored at a lower temperature.

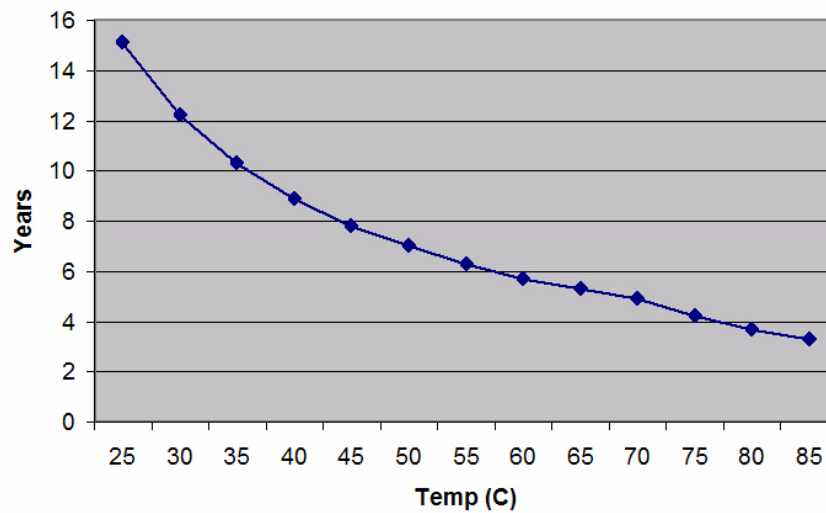

Figure 11. Battery Life vs. Storage Temperature

CPU

Intel® Atom™ D425 and D525 processors include the following key features:

- On die, primary 32-kB instructions cache and 24-kB write-back data cache
- Intel® Hyper-Threading Technology 2-threads per core
- On die 2 x 512-kB, 8-way L2 cache for D500 dual-core processor, 1 x 512-kB, 8-way L2 cache for D400 single-core processor

Processor memory features include:

- Support for DDR3 at data transfer rate of 800 MT/s
- I/O Voltage of 1.5 V for DDR3

Integrated graphics features include:

- The GPU contains a refresh of the 3rd generation graphics core
- Intel® Dynamic Video Memory Technology support 4.0
- Directx 9 compliant Pixel Shader v2.0
- 400 MHz render clock frequency
- Two display ports: LVDS and RGB
- Intel® Clear Video Technology

System RAM

The Iguana accepts one 204-pin DDR3 SO-DIMM memory module with the following characteristics:

- Size Up to 2GB (1GB or 2GB recommended)
- Voltage +1.5V
- Type DDR3, 800 MT/s (400 MHz clock)

Clearing Non-volatile RAM (NVRAM)

You can clear NVRAM and reset the BIOS settings to factory defaults by following the instructions below.

1. Power off the Iguana.
2. Install a jumper on V6[1-2].
3. Power on the Iguana and wait 10 seconds or more.
4. Power off the Iguana.
5. Remove the jumper from V6[1-2]. The board will not boot if you do not remove this jumper.
6. Power on the Iguana.

Real-Time Clock (RTC)

The Iguana features a battery-backed real-time clock/calendar chip. Under normal battery conditions, the clock maintains accurate timekeeping functions when the board is powered off.

The accuracy of the RTC clock is ± 20 ppm (parts per million) at 25° C, which equates to approximately ± 1.7 seconds per day of clock drift error (± 20 ppm is the crystal frequency accuracy). The RTC accuracy varies with temperature. The approximate clock accuracy at any temperature T (in C) can be calculated as follows:

$$\text{ppm} = [1 - 0.04(T-25)^2] \pm 20 \text{ (in ppm)}$$

$$\text{clock drift error} = 0.0864 \times \text{ppm (in seconds per day)}$$

For example, at -40° C the ppm = -168 ± 20 ppm. For the worst case crystal accuracy of -20 ppm, the ppm = -188 ppm, which equates to -16.2 seconds per day.

SETTING THE CLOCK

The [Main BIOS setup screen](#) (accessed by pressing the Delete key during the early boot cycle, or F4 if operating in terminal mode) can be used to set the time and date of the real-time clock.

CLEARING THE REAL-TIME CLOCK

You can move the V3 jumper to position [2-3] for a minimum of two seconds to clear the RTC. When clearing the RTC:

1. Power off the Iguana.
2. Move the jumper from V3[1-2] to V3[2-3] and leave it for two or more seconds.
3. Return the jumper to V3[1-2]. (The board will not boot if the jumper is not returned to this position.)
4. Power on the Iguana.

This procedure sets the RTC date to Sat 01/01/2011. The time is not reset by this procedure; however, the time is reset to 00:00:00 if battery power is lost.

Console Redirection

The Iguana can be configured for remote access by redirecting the console to a serial communications port. The BIOS setup utility and some operating systems such as DOS can use this console for user interaction.

Console redirection settings are configured in the [Serial Port Console Redirection BIOS setup screen](#). Console redirection is disabled by default.

Console redirection can be disabled or redirected to one or more COM ports that will share the video console. The default settings for the redirected console are 115.2 kbps, 8 data bits, 1 stop bit, no parity, and no flow control.

Null Modem

The following figure illustrates a typical DB9 to DB9 RS-232 null modem adapter.

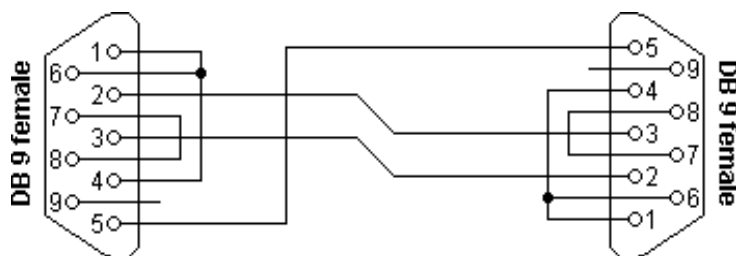

Figure 12. Null Modem with Loop-back Handshaking

Pins 1, 4, and 6 are shorted together on each connector.

Expansion Buses

Note Some information in this section may change as the BIOS continues in development.

PC/104-Plus (PCI + ISA) AND PCI-104 (PCI ONLY)

PC/104-Plus and PCI-104 modules can be secured directly to the top of the Iguana. Make sure to correctly configure the slot position jumpers on each PC/104-Plus module appropriately. PC/104 (ISA only) modules must not be positioned between the Iguana and any PC/104-Plus or PCI-104 modules in the stack.

The VL-EPIC-25 is compliant with revision 2.0 of the PC/104-Plus specification and can support four bus master capable PC/104-Plus modules.

The BIOS automatically allocates I/O and memory resources. However, manual PCI Interrupt routing is used.

The following table shows the maximum PC/104-Plus slot power on the Iguana.

Table 5: Maximum PC/104-Plus Slot Power

Voltage	Max. Current
+5V	8A
+3.3V	4A
+12V	1A
-12V	0.5A

PC/104 ISA

The Iguana provides full support of the PC/104 bus, with the following exceptions:

- -5.0V power is not supplied on J7 pin B5. This pin is not connected.
- The ISA bus cannot be mastered by an external module. The Iguana is always the bus master. The MASTER signal on pin D17 of J8 is not connected.
- DMA not supported.

Most PC/104 cards will work, but be sure to check the requirements of your PC/104 card against the list above.

PC/104 I/O SUPPORT

The following I/O ranges are available on the ISA bus unless there is a device claiming the range on the LPC bus (COM and LPT ports). Be sure to configure the ISA I/O ranges and the onboard serial ports in BIOS setup to avoid conflicts with one another. (An OS will not allocate I/O in the legacy ISA range.)

- | | | | |
|-----------------|-----------------|-----------------|-----------------|
| ▪ 0x019 – 0x01E | ▪ 0x062 – 0x063 | ▪ 0x0D2 – 0x0DD | ▪ 0x3F7 |
| ▪ 0x022 – 0x023 | ▪ 0x065 – 0x070 | ▪ 0x0E0 – 0x0EF | ▪ 0x400 – 0x47F |
| ▪ 0x026 – 0x027 | ▪ 0x078 – 0x07F | ▪ 0x0F1 – 0x16F | ▪ 0x4C0 – 0x4CF |
| ▪ 0x02A – 0x02B | ▪ 0x0A2 – 0x0A3 | ▪ 0x178 – 0x1EF | ▪ 0x4D2 – 0x7FF |
| ▪ 0x032 – 0x033 | ▪ 0x0A6 – 0x0A7 | ▪ 0x1F8 – 0x2E7 | ▪ 0x880 – 0xBFF |
| ▪ 0x036 – 0x037 | ▪ 0x0AA – 0x0AB | ▪ 0x2F0 – 0x2F7 | ▪ 0xCC0 – 0xCF8 |
| ▪ 0x03A – 0x03B | ▪ 0x0AE – 0x0AF | ▪ 0x300 – 0x375 | ▪ 0xCFA – 0xCFB |
| ▪ 0x03E – 0x03F | ▪ 0x0B6 – 0x0B7 | ▪ 0x377 – 0x3BF | ▪ 0xD00 |
| ▪ 0x043 – 0x04D | ▪ 0x0BA – 0x0BB | ▪ 0x3E0 – 0x3E7 | |
| ▪ 0x053 – 0x05F | ▪ 0x0BE – 0x0BF | ▪ 0x3F0 – 0x3F5 | |

Available base I/O addresses for COM ports are: 2E8h, 2F8h, 3E8h, 3F8h.

PC/104 MEMORY SUPPORT

The following memory addresses are available on the ISA bus:

- 0xA0000 – 0xB7FFF
- 0xD0000 – 0xDFFFF

PC/104 IRQ SUPPORT

Interrupts are routed automatically, though manual routing control may be added in future BIOS releases. First the COM ports are assigned IRQs according to the Serial Port Configuration settings. Next the PCI devices are assigned IRQs. After an OS loads and transitions from 8259 to APIC mode, these PCI IRQs will be freed and available for legacy use. In the 1.00 BIOS, VersaLogic recommends IRQ6 for ISA bus use in a OS using the legacy 8259 interrupt controller.

Because ISA IRQ sharing is not supported, IRQs may not be available to the ISA bus due to operating system limitations.

Ethernet Interface

The Iguana features two on-board Intel 82574IT Gigabit Ethernet controllers. The controllers provide a standard IEEE 802.3 Ethernet interface for 1000Base-T, 100Base-TX, and 10Base-T applications. RJ45 connectors are located at locations J22 (Ethernet 1) and J20 (Ethernet 0). While these controllers are not NE2000-compatible, they are widely supported. Drivers are readily available to support a variety of operating systems. These interfaces are protected against ESD damage.

ETHERNET CONNECTORS

Two board-mounted RJ45 connectors are provided to make connection with Category 5 or 6 Ethernet cables. The 82574IT Ethernet controller auto-negotiates connection speed. These interfaces use IEC 61000-4-2-rated TVS components to help protect against ESD damage.

ETHERNET STATUS LEDs

On-board status LEDs are provided at locations D7 (single yellow) and D8 (dual green/yellow) for Ethernet 0, and D9 (single yellow) and D10 (dual green/yellow) for Ethernet 1. These LEDs provide an indication of the Ethernet status as shown in the following table.

Table 6: On-board Ethernet Status LEDs

LED	State	Description
Green/Yellow (Link Speed)	Yellow	1 Gbps speed
	Green	100 Mbps speed
	Off	10 Mbps speed or cable not connected
Yellow (Activity)	On	Cable connected (intermittent with activity)
	Off	Cable not connected

STATUS LED

Connector J28 provides an additional on-board Ethernet status LED interface. The +3.3V power supplied to this connector is protected by a 1 Amp fuse.

Table 7: Ethernet Status LED Pinout

J28 Pin	Signal Name	Function	On-Board LED Equivalent
1	+3.3V	Protected Power Supply	—
2	YEL1	Yellow LED - Ethernet 0	D7 – Yellow
3	ORN1	Orange LED - Ethernet 0	D8 – Yellow
4	GRN1	Green LED - Ethernet 0	D8 – Green
5	+3.3V	Protected Power Supply	D9 – Yellow
6	YEL2	Yellow LED - Ethernet 1	D10 – Yellow
7	ORN2	Orange LED - Ethernet 1	D10 – Green
8	GRN2	Green LED - Ethernet 1	—
9	GND	Ground	—
10	W_DISABLE#	PCIe Mini Card Disable*	—

* This pin can be connected to the Disable signal on the PCIe Mini Card (pin 20) on custom models.

SATA Interface

The Iguana provides two serial ATA (SATA) ports, which communicate at a rate of up to 3.0 GB/s (SATA 2). The SATA connectors at locations J11 and J12 are standard 7-pin straight SATA connectors with friction latching. Power to SATA drives is supplied by the ATX power supply. Note that the standard SATA drive power connector is different than the common 4-pin Molex connector used on IDE drives. Most current ATX power supplies provide SATA connectors, and many SATA drives provide both types of power connectors. If the power supply you are using does not provide SATA connectors, adapters are available.

Table 8: SATA Port Pinout

J11 or J12 Pin	Signal Name	Function
1	GND	Ground
2	TX+	Transmit +
3	TX-	Transmit -
4	GND	Ground
5	RX-	Receive -
6	RX+	Receive +
7	GND	Ground

The blue LED at location D11 (upper right corner of the board as shown in Figure 7) lights with disk activity on the SATA ports.

Serial Ports

The Iguana features four on-board 16550-based serial communications channels located at standard PC I/O addresses. All serial ports can be operated in RS-232 4-wire, RS-422, or RS-485 modes. IRQ lines are chosen in BIOS setup. Each COM port can be independently enabled, disabled, or assigned a different I/O base address in BIOS setup.

COM PORT CONFIGURATION

Use the BIOS setup screens to select between RS-232 and RS-422/485 operating modes.

Jumper block V4 is used to configure serial ports for RS-422/485 operation. See “Jumper Summary” for details. The termination resistor should be enabled for RS-422 and the RS-485 endpoint stations. It should be disabled for RS-232 and RS-485 intermediate stations.

If RS-485 mode is used, the differential twisted pair (TxD+/RxD+ and TxD-/RxD-) is formed by connecting both transmit and receive pairs together. For example, on CBR-5013 connectors J6 and J5, the TxD+/RxD+ signal is formed by connecting pins 3 and 5, and the TxD-/RxD- signal is formed by connecting pins 2 and 4.

RS-485 MODE LINE DRIVER CONTROL

The TxD+/TxD- differential line driver is automatically turned on and off based on data availability in the UART output FIFO.

SERIAL PORT CONNECTORS

The pinouts of the DB9M connectors apply to the serial connectors on the VersaLogic breakout board VL-CBR-5013.

These connectors use IEC 61000-4-2-rated TVS components to help protect against ESD damage.

Table 9: COM0-1 Pinout – VL-CBR-5013 Connector J2

COM0 Top DB9 J2 Pin	COM1 Bottom DB9 J2 Pin	RS-232	RS-422	RS-485
1	1	—	—	—
2	2	RXD*	RxD-	RxD-
3	3	TXD*	TxD-	TxD-
4	4	—	—	—
5	5	Ground	Ground	Ground
6	6	—	—	—
7	7	RTS	TxD+	TxD+
8	8	CTS	RxD+	RxD+
9	9	—	—	—

Table 10: COM2-3 Pinout – VL-CBR-5013 Connectors J5-6

COM2 J5 Pin	COM3 J6 Pin	RS-232	RS-422	RS-485
1	1	Ground	Ground	Ground
2	2	RXD	RxD-	RxD-
3	3	CTS	RxD+	RxD+
4	4	TXD	TxD-	TxD-
5	5	RTS	TxD+	TxD+

USB Interface

The USB interface on the Iguana is UHCI (Universal Host Controller Interface) and EHCI (Enhanced Host Controller Interface) compatible, which provides a common industry software/hardware interface. The Iguana provides six Type A USB host connectors at locations J16 and J17 on the motherboard, and dual connectors J1 and J7 on the VL-CBR-5013 paddleboard. Two more USB channels are available through the PCIe Mini Card connector at J13 and the eUSB connector at J18.

Flash Interfaces

COMPACTFLASH

Connector J9 provides a socket for a Type I or Type II CompactFlash (CF) module. The CF interface supports operation in DMA mode. Contact [VersaLogic Sales](#) to order CF modules that have been tested and qualified as bootable devices.

After installing the OS on the CF, you may configure the module to be the first boot device, which will reduce boot time.

The blue LED at location D11 (upper right corner of the board as shown in Figure 7) lights with disk activity on the CF port.

EUSB SOCKET

The Iguana includes an eUSB port. The VersaLogic VL-F15 Series of eUSB SSD modules are available in sizes of 2 GB or 4 GB. Contact [VersaLogic Sales](#) to order. eUSB modules are secured to the on-board standoff using M2.5 x 6mm pan head Philips nylon screws. These screws are available in quantities of 10 in the VL-HDW-108 hardware kit from VersaLogic.

Table 11: eUSB Port Locations

J18 Pin	Signal Name	Function
1	+5V	+5V Power Supply
2	NC	Not connected
3	D-	Data -
4	NC	Not connected
5	D+	Data +
6	NC	Not connected
7	GND	Ground
8	NC	Not connected
9	Key	Physical key
10	LED	SSD LED

The blue LED at location D6 (upper right corner of the board as shown in Figure 7) lights with activity on the eUSB port, if supported by the eUSB module.

PCIe MINI CARD / mSATA SOCKET

The socket at location J13 accepts a full-height PCI Express Mini Card or an mSATA module.

The PCIe Mini Card interface includes one PCIe x1 lane, one USB 2.0 channel, and the SMBus interface. The socket is compatible with plug-in Wi-Fi modems, GPS receivers, flash data storage, and other cards for added flexibility. An Intel WiFi Link 5300 PCI Express Mini Card (VL-WD10-CBN) is available from VersaLogic. A WiFi antenna (VL-CBR-ANT01) and a 12" WiFi card to bulkhead RP-SMA transition cable (VL-CBR-0201) are also available. For more information, contact Sales@VersaLogic.com.

The VL-MPEs-F1E series of mSATA modules provide flash storage of 4 GB, 16 GB, or 32 GB.

To secure a Mini Card or mSATA module to the on-board standoffs, use two M2.5 x 6mm pan head Philips nylon screws. These screws are available in quantities of 10 in the VL-HDW-108 hardware kit from VersaLogic.

Table 12: PCIe Mini Card / mSATA Pinout

J13 Pin	PCIe Mini Card Signal Name	PCIe Mini Card Function	mSATA Signal Name	mSATA Function
1	WAKE#	Wake	Reserved	Not connected
2	3.3VAUX	3.3V auxiliary source	+3.3V	3.3V source
3	NC	Not connected	Reserved	Not connected
4	GND	Ground	GND	Ground
5	NC	Not connected	Reserved	Not connected
6	1.5V	1.5V power	+1.5V	1.5V power
7	CLKREQ#	Reference clock request	Reserved	Not connected
8	NC	Not connected	Reserved	Not connected
9	GND	Ground	GND	Ground
10	NC	Not connected	Reserved	Not connected
11	REFCLK-	Reference clock input –	Reserved	Not connected
12	NC	Not connected	Reserved	Not connected
13	REFCLK+	Reference clock input +	Reserved	Not connected
14	NC	Not connected	Reserved	Not connected
15	GND	Ground	GND	Ground
16	NC	Not connected	Reserved	Not connected
17	NC	Not connected	Reserved	Not connected
18	GND	Ground	GND	Ground
19	NC	Not connected	Reserved	Not connected
20	W_DISABLE#	Wireless disable ¹	Reserved	Not connected
21	GND	Ground	GND	Ground
22	PERST#	Card reset	Reserved	Not connected
23	PERn0	PCIe receive –	+B	Host receiver diff. pair +
24	3.3VAUX	3.3V auxiliary source	+3.3V	3.3V source
25	PERp0	PCIe receive +	-B	Host receiver diff. pair –
26	GND	Ground	GND	Ground
27	GND	Ground	GND	Ground
28	1.5V	1.5V power	+1.5V	1.5V power
29	GND	Ground	GND	Ground
30	SMB_CLK	SMBus clock	Two Wire I/F	Two wire I/F clock
31	PETn0	PCIe transmit –	-A	Host transmitter diff. pair –
32	SMB_DATA	SMBus data	Two Wire I/F	Two wire I/F data
33	PETp0	PCIe transmit +	+A	Host transmitter diff. pair +
34	GND	Ground	GND	Ground
35	GND	Ground	GND	Ground
36	USB_D-	USB data –	Reserved	Not connected
37	GND	Ground	GND	Ground
38	USB_D+	USB data +	Reserved	Not connected
39	3.3VAUX	3.3V auxiliary source	+3.3V	3.3V source
40	GND	Ground	GND	Ground

J13 Pin	PCIe Mini Card Signal Name	PCIe Mini Card Function	mSATA Signal Name	mSATA Function
41	3.3VAUX	3.3V auxiliary source	+3.3V	3.3V source
42	LED_WWAN#	Wireless WAN LED	Reserved	Not connected
43	GND	mSATA Detect ²	GND/NC	Ground/Not connected ³
44	LED_WLAN#	Wireless LAN LED	Reserved	Not connected
45	NC	Not connected	Vendor	Not connected
46	LED_WPAN#	Wireless PAN LED	Reserved	Not connected
47	NC	Not connected	Vendor	Not connected
48	1.5V	1.5V power	+1.5V	1.5V power
49	Reserved	Reserved	DA/DSS	Device activity ⁴
50	GND	Ground	GND	Ground
51	Reserved	Reserved	GND	Ground ⁵
52	3.3VAUX	3.3V auxiliary source	+3.3V	3.3V source

Notes:

1. This signal can be driven by GPIO24 from the ICH8M or as a custom option from Pin 10 on the Ethernet LED connector at location J28.
2. This pin is not grounded on the Iguana since it can be used to detect the presence of an mSATA module versus a PCIe Mini Card. Grounding this pin is available as an option on custom boards.
3. This pin is not grounded on the Iguana to make it available for mSATA module detection.
4. This signal drives the blue LED activity indicator at location D11 (upper right corner of the board as shown in Figure 6). This LED lights with mSATA disk activity, if supported by the mSATA module.
5. Some PCIe modules use this signal as a second Mini Card wireless disable input. On the Iguana, this signal is available for use for mSATA versus PCIe Mini Card detection. There is an option on the VersaLogic Features BIOS setup screen for setting the mSATA detection method.

PCIe MINI CARD WIRELESS STATUS LEDs

Three wireless status LEDs are provided on the Iguana at locations D4 and D5:

- D4 Yellow – Wireless WAN
- D5 Green – Wireless LAN
- D5 Yellow – Wireless PAN

These LEDs light when the associated device is installed and capable of transmitting.

Video

An on-board video controller integrated into the chipset provides high-performance video output for the Iguana. The controller supports dual, simultaneous, independent video output. The Iguana can also be operated without video attached (see Console Redirection).

The Iguana supports two types of video output, SVGA and LVDS Flat Panel Display.

SVGA OUTPUT CONNECTOR

An adapter cable, part number VL-CBR-1201, is available to translate J2 into a standard 15-pin D-Sub SVGA connector. This connector is protected against ESD damage.

Table 13: Video Output Pinout

J2 Pin	Signal Name	Function	Mini DB15 Pin
1	GND	Ground	6
2	RED	Red Video	1
3	GND	Ground	7
4	GREEN	Green Video	2
5	GND	Ground	8
6	BLUE	Blue Video	3
7	GND	Ground	5
8	HSYNC	Horizontal Sync	13
9	GND	Ground	10
10	VSYNC	Vertical Sync	14
11	SCL	DDC Serial Data Line Clock	15
12	SDA	DDC Serial Data Line	12

LVDS FLAT PANEL DISPLAY CONNECTOR

The integrated LVDS Flat Panel Display in the VL-EPIC-25 is an ANSI/TIA/EIA-644-1995 specification-compliant interface. It can support up to 18 bits of RGB pixel data plus 3 bits of timing control (HSYNC/VSYNC/DE) on the 4 differential data output pairs. The LVDS clock frequency ranges from 25 MHz to 112 MHz.

Iguana has one LVDS connector at location J3.

BIOS setup provides several options for standard LVDS flat panel types. If these options do not match the requirements of the panel you are attempting to use, contact Support@VersaLogic.com for a custom video BIOS.

Table 14: LVDS Flat Panel Display Pinout

J3 Pin	Signal Name	Function
1	GND	Ground
2	NC	Not Connected
3	NC	Not Connected
4	NC	Not Connected
5	GND	Ground
6	LVDSCLK0	Differential Clock (+)
7	LVDSCLK0#	Differential Clock (-)
8	GND	Ground
9	LVDSA2	Diff. Data 2 (+)
10	LVDSA2#	Diff. Data 2 (-)
11	GND	Ground
12	LVDSA1	Diff. Data 1 (+)
13	LVDSA1#	Diff. Data 1 (-)
14	GND	Ground
15	LVDSA0	Diff. Data 0 (+)
16	LVDSA0#	Diff. Data 0 (-)
17	GND	Ground
18	GND	Ground
19	+3.3V	+3.3V (Protected)
20	+3.3V	+3.3V (Protected)

The +3.3V power provided to pins 19 and 20 of J3 is protected by a software-controllable power switch (1 Amp max.). This switch is controlled by the LVDD_EN signal from the LVDS interface controller in the CPU.

Note: A +5V power option is available on custom models.

Audio

The audio interface on the Iguana is implemented using an Integrated Device Technology, Inc. 92HD87B1X5 Audio Codec. This interface is Intel High Definition Audio compatible. Drivers are available for most Windows-based and Linux operating systems. To obtain the most current versions, consult the Iguana product support page.

The J19 main I/O connector provides the line-level stereo input and line-level stereo output connection points. The outputs will drive most amplified PC speaker sets.

The following table shows the pinout of the audio connector J3 on the VL-CBR-5013 breakout board.

Table 15: VL-CBR-5013 J3 Audio Connector Pinout

J3 Pin	Signal Name	Function
1	LINE_INL	Line-In Left
2	LINE_INR	Line-In Right
3	HDA_GND	HDA Ground
4	LINE_OUTL	Line-Out Left
5	LINE_OUTR	Line-Out Right
6	HDA_GND	HDA Ground

Note: In Windows, the rear line-in audio input is configured by default as a microphone input. To configure it for audio input, disable the microphone boost to eliminate audio distortion.

User I/O Connector

The 50-pin user I/O connector (J19) incorporates the COM ports, four USB ports, programmable LED, power LED, pushbutton reset, power button, audio line in/out, and speaker interfaces. The table below illustrates the function of each pin.

Table 16: User I/O Connector Pinout

J19 Pin	CBR-5013 Connector	Signal		J19 Pin	CBR-5013 Connector	Signal
		RS-232	RS-422/485			
				25	USB 4	USB4-5 +5.0V
1	COM0 J2 Top DB9	Ground	Ground	26		Data +
2		RXD	RxD-	27		Data -
3		CTS	RxD+	28	USB 5	USB4-5 +5.0V
4		Ground	Ground	29		Data +
5		TXD	TxD-	30		Data -
6		RTS	TxD+	31	USB 6	USB6-7 +5.0V
7	COM1 J2 Bottom DB9	Ground	Ground	32		Data +
8		RXD	RxD-	33		Data -
9		CTS	RxD+	34	USB 7	USB6-7 +5.0V
10		Ground	Ground	35		Data +
11		TXD	TxD-	36		Data -
12		RTS	TxD+	37		+5.0V (Protected)
13	COM2 J5	Ground	Ground	38	D1	Programmable LED
14		RXD	RxD-	39	SP1	Speaker
15		CTS	RxD+	40	S2, J8 Pin 1	Pushbutton Reset
16		Ground	Ground	41	S1, J8 Pin 3	Power Button
17		TXD	TxD-	42		Ground
18		RTS	TxD+	43	Audio In J3 Top	Audio In Left
19	COM3 J6	Ground	Ground	44		HDA ground (isolated)
20		RXD	RxD-	45		Audio In Right
21		CTS	RxD+	46		HDA ground (isolated)
22		Ground	Ground	47	Audio Out J3 Bottom	Audio Out Left
23		TXD	TxD-	48		HDA ground (isolated)
24		RTS	TxD+	49		Audio Out Right
			50	HDA ground (isolated)		

Pushbutton Reset

Connector J19 includes an input for a pushbutton reset switch. Shorting J19 pin 40 to ground causes the Iguana to reboot. This must be a mechanical switch or an open-collector or open-drain active switch with less than a 0.5V low-level input when the current is 1 mA. There must be no pull-up resistor on this signal.

This connector uses IEC 61000-4-2-rated TVS components to help protect against ESD damage.

A reset button is provided on the VL-CBR-5013 breakout board. Terminal block J8 on the breakout board also provides a reset signal on pin 1 and ground on pin 2.

Power Button

Connector J19 includes an input for a power button. Shorting J19 pin 41 to ground causes the board to enter an S5 power state (similar to the Windows Shutdown state). Shorting it again will return the board to the S0 power state and reboot the board. The button can be configured in Windows to enter an S3 power state (Sleep, Standby, or Suspend-to-RAM), an S4 power state (Hibernate or Suspend-to-Disk), or an S5 power state (Shutdown or Soft-Off).

This connector uses IEC 61000-4-2-rated TVS components to help protect against ESD damage.

A power button is provided on the VL-CBR-5013 breakout board. Terminal block J8 also provides a power button signal on pin 3 and ground on pin 2.

In configurations where a power button is not connected to the board, if the system is put into an S5 state, power can be restored by turning off the power supply and turning it back on. This behavior is set by default by the BIOS. The behavior can be changed using the Restore AC Power Loss parameter on the Chipset > South Bridge menu of the BIOS setup screens.

SUPPORTED POWER STATES

The Iguana supports the following power states:

- S0 (G0): Working.
- S1 (G1-S1): All processor caches are flushed, and the CPUs stop executing instructions. Power to the CPUs and RAM is maintained. Devices that do not indicate they must remain on may be powered down.
- S3 (G1-S3): Commonly referred to as Standby, Sleep, or Suspend-to-RAM. RAM remains powered.
- S4 (G1-S4): Hibernation or Suspend-to-Disk. All content of main memory is saved to non-volatile memory, such as a hard drive, and is powered down.
- S5 (G2): Soft Off. Almost the same as G3 Mechanical Off, except that the power supply still provides power, at a minimum, to the power button to allow return to S0. A full reboot is required. No previous content is retained. Other components may remain powered so the computer can "wake" on input from the keyboard, clock, modem, LAN, or USB device.
- G3: Mechanical off (ATX supply switch turned off).

External Speaker

Connector J19 includes a speaker output signal at pin 39. The VL-CBR-5013 breakout board provides a Piezo electric speaker.

LEDs

PROGRAMMABLE LED

Connector J19 includes an output signal for a programmable LED. Connect the cathode of the LED to J19 pin 38; connect the anode to +5V. A 332 Ω on-board resistor limits the current to 15 mA when the LED is shorted. A programmable LED is provided on the VL-CBR-5013 breakout board. The programmable LED is the top LED at position D1.

To turn the LED on and off, set or clear bit D7 in I/O port CA0h. When changing the register, make sure not to alter the value of the other bits.

The following code examples show how to turn the LED on and off.

LED On		LED Off	
MOV	DX, CA0H	MOV	DX, CA0H
IN	AL, DX	IN	AL, DX
OR	AL, 80H	AND	AL, 7FH
OUT	DX, AL	OUT	DX, AL

POWER LED

The power LED on the VL-CBR-5013 indicates that the paddle board is being powered by the 5V supply (though it does not indicate that all S0 power supplies are good). The LED is lit only on when the board is in the S0 power state. If the board enters a Sleep or Hibernate mode, the LED will not be lit.

There is also an on-board green "Power-OK" LED (at location D4). This will illuminate when all power rails are good, and indicates that the board is in the S0 power state. If any power rail is not good, the LED will not illuminate. It also goes out when the board enters a sleep or hibernate power mode.

Digital I/O

The 40-pin I/O connector (J25) incorporates 16 digital I/O lines. Table 17 shows the function of each pin. The digital I/O lines are controlled using the SPI registers. See "SPI Registers" for a complete description of the registers.

The digital lines are grouped into two banks of 16-bit bi-directional ports. The direction of each 8-bit port is controlled by software. The digital I/O lines are powered up in the input mode. The 24 mA source/sink drive and short protected outputs are an excellent choice for industrial LVTTTL interfacing. All I/O pins use +3.3V signaling.

Warning! Damage may occur if the I/O pins are connected to +5V logic.

Table 17: J25 I/O Connector Pinout

J25 Pin	Signal	VL-CBR-4004 Connector	VL-CBR-4004 Pin (Label)
16	Digital I/O 1	J4	5 (IO13)
17	Digital I/O 2		4 (IO14)
18	Digital I/O 3		3 (IO15)
19	Digital I/O 4		2 (IO16)
20	Ground		1 (GND2)
21	Digital I/O 5	J6	1 (IO17)
22	Digital I/O 6		2 (IO18)
23	Digital I/O 7		3 (IO19)
24	Digital I/O 8		4 (IO20)
25	Ground		5 (GND3/PBRST#)
26	Digital I/O 9	J7	1 (IO21)
27	Digital I/O 10		2 (IO22)
28	Digital I/O 11		3 (IO23)
29	Digital I/O 12		4 (IO24)
30	Ground		5 (GND3)
31	Digital I/O 13	J8	1 (IO25)
32	Digital I/O 14		2 (IO26)
33	Digital I/O 15		3 (IO27)
34	Digital I/O 16		4 (IO28)
35	Ground		5 (GND4)

Note: Connector J6 pin 5 on the CBR-4004 is labeled "GND3/PBRST#" for compatibility with other VersaLogic CPU boards. When connected to the Iguana, this pin is GND3.

DIGITAL I/O PORT CONFIGURATION USING THE SPI INTERFACE

Digital I/O channels 0-15 are accessed via SPI slave select 6 (writing 6h to the SS field in SPICONTROL). Each pair of I/O ports is configured by a set of paged I/O registers accessible through SPI. These registers control settings such as signal direction, input polarity, and interrupt source.

Digital I/O Interrupt Generation Using the SPI Interface

Digital I/O can be configured to issue hardware interrupts on the transition (high to low or low to high) of any digital I/O pin. IRQ assignment is made in SPI control register SPISTATUS. This IRQ is shared among all SPI devices connected to the Iguana (the ADC and DAC devices on the SPI interface do not have interrupts). Digital I/O chip interrupt configuration is achieved through I/O port register settings. Please refer to the [Microchip MCP23S17 datasheet](#) for more information.

The on-board digital I/O chips must be configured for open-drain and mirrored interrupts in order for any SPI device to use hardware interrupts. The following code example illustrates how to do this for device #0 on channels 0-15. Normally, the BIOS initializes the on-board digital I/O chips at boot time.

```

MOV    DX, CA8h
MOV    AL, 26h      ;SPICONTROL: SPI Mode 00, 24bit, auto SPI 6
OUT    DX, AL
MOV    DX, CA9h
MOV    AL, 30h     ;SPISTATUS: 8MHz, no IRQ, left-shift
OUT    DX, AL
MOV    DX, CABh
MOV    AL, 44h     ;SPIDATA1: Mirror & Open-Drain interrupts
OUT    DX, AL
MOV    DX, CACH
MOV    AL, 0Ah     ;SPIDATA2: MCP23S17 address 0x0A
OUT    DX, AL
MOV    DX, CADh
MOV    AL, 40h     ;SPIDATA3: MCP23S17 write command
OUT    DX, AL

BUSY:  MOV    DX, CA9h
        IN     AL, DX      ;Get SPI status
        AND    AL, 01h     ;Isolate the BUSY bit
        JNZ   BUSY        ;Loop back if SPI transaction is not complete

MOV    DX, CA8h
MOV    AL, 27h     ;SPICONTROL: SPI Mode 00, 24bit, auto SPI 6
OUT    DX, AL
MOV    DX, CA9h
MOV    AL, 30h     ;SPISTATUS: 8MHz, no IRQ, left-shift
OUT    DX, AL
MOV    DX, CABh
MOV    AL, 44h     ;SPIDATA1: Mirror & Open-Drain interrupts
OUT    DX, AL
MOV    DX, CACH
MOV    AL, 0Ah     ;SPIDATA2: MCP23S17 address 0x0A
OUT    DX, AL
MOV    DX, CADh
MOV    AL, 40h     ;SPIDATA3: MCP23S17 write command
OUT    DX, AL

```

Writing to a Digital I/O Port Using the SPI Interface

The following code example initiates a write of 55h to Digital I/O port bits DIO15-DIO8.

```

;Write 44h to configure MCP23S17 register IOCON

```

```

MOV     DX, CA8h
MOV     AL, 26h      ;SPICONTROL: SPI Mode 00, 24bit, SPI 6
OUT     DX, AL
MOV     DX, CA9h
MOV     AL, 30h      ;SPISTATUS: 8MHz, no IRQ, left-shift
OUT     DX, AL
MOV     DX, CABh
MOV     AL, 44h      ;SPIDATA1: mirror and open-drain interrupts
OUT     DX, AL
MOV     DX, CACH
MOV     AL, 0Ah      ;SPIDATA2: MCP23S17 IOCON register address 0Ah
OUT     DX, AL
MOV     DX, CADh
MOV     AL, 40h      ;SPIDATA3: MCP23S17 write command
OUT     DX, AL
CALL    BUSY        ;Poll busy flag to wait for SPI transaction

;Configure MCP23S17 register IODIRA for outputs

MOV     DX, CABh
MOV     AL, 00h      ;SPIDATA1: 00h for outputs
OUT     DX, AL
MOV     DX, CACH
MOV     AL, 00h      ;SPIDATA2: MCP23S17 register address 00h
OUT     DX, AL
MOV     DX, CADh
MOV     AL, 40h      ;SPIDATA3: MCP23S17 write command
OUT     DX, AL
CALL    BUSY        ;Poll busy flag to wait for SPI transaction

;Write 55h to MCP23S17 register GPIOA

MOV     DX, CABh
MOV     AL, 55h      ;SPIDATA1: data to write
OUT     DX, AL
MOV     DX, CACH
MOV     AL, 14h      ;SPIDATA2: MCP23S17 register address 14h
OUT     DX, AL
MOV     DX, CADh
MOV     AL, 40h      ;SPIDATA3: MCP23S17 write command
OUT     DX, AL
CALL    BUSY        ;Poll busy flag to wait for SPI transaction

BUSY:   MOV     DX, CA9h
        IN      AL, DX      ;Get SPISTATUS
        AND     AL, 01h     ;Isolate the BUSY flag
        JNZ    BUSY        ;Loop if SPI transaction not complete

```

Reading a Digital I/O Port Using the SPI Interface

The following code example reads the DIO15-DIO8 input lines.

```

'REGISTER ASSIGNMENT
'-----
CONST SPICONTROL1 = &HCA8
CONST SPICONTROL2 = &HCA9
CONST SPISTATUS = &HCA9
CONST SPIDATA1 = &HCAB
CONST SPIDATA2 = &HCAC
CONST SPIDATA3 = &HCAD

'INITIALIZE SPI CONTROLLER

```

```

'=====
'SPICONTROL1 Register
'-----
'D7 CPOL      = 0 SPI Clock Polarity (SCLK idles low)
'D6 CPHA      = 0 SPI Clock Phase (Data read on rising edge)
'D5 SPILEN1   = 1 SPI Frame Length (24-Bit)
'D4 SPILEN0   = 0 " " " "
'D3 MAN_SS    = 0 SPI Slave Select Mode (Automatic)
'D2 SS2       = 1 SPI Slave Select (On-Board DIO 0-15)
'D1 SS1       = 1 " " " "
'D0 SS0       = 0 " " " "
OUT SPICONTROL1, &H26

'SPICONTROL2 Register
'-----
'D7 IRQSEL1   = 0 IRQ Select (IRQ3)
'D6 IRQSEL0   = 0 " " "
'D5 SPICLK1   = 1 SPI SCLK Frequency (8.333 MHz)
'D4 SPICLK0   = 1 " " " "
'D3 HW_IRQ_EN = 0 Hardware IRQ Enable (Disabled)
'D2 LSBIT_1ST = 0 SPI Shift Direction (Left Shifted)
'D1 0         = 0 This bit has no function
'D0 0         = 0 This bit has no function
OUT SPICONTROL2, &H30

'INITIALIZE MCP23S17
'=====

'MCP23S17 IOCON Register
'-----
'D7 BANK      = 0 Registers in same bank (addresses are sequential)
'D6 MIRROR    = 1 The INT pins are internally connected
'D5 SEQOP     = 0 Sequential op disabled. Addr ptr does not increment.
'D4 DISSLW    = 0 Slew rate control for SDA output (enabled)
'D3 HAEN      = 0 Hardware address enable (addr pins disabled)
'D2 ODR       = 1 INT pin is open-drain
'D1 INTPOL    = 0 Polarity of INT output pin (ignored when ODR=1)
'D0 0         = 0 This bit has no function
OUT SPIDATA1, &H44

'MCP23S17 IOCON Register Address
'-----
OUT SPIDATA2, &HA

'MCP23S17 SPI Control Byte (Write)
'-----
'D7 SLAVEFA3  = 0 Slave Address (Fixed Portion)
'D6 SLAVEFA2  = 1 " " " "
'D5 SLAVEFA1  = 0 " " " "
'D4 SLAVEFA0  = 0 " " " "
'D3 SLAVEHA2  = 0 Slave Address Bits (Hardware Address Bits)
'D2 SLAVEHA1  = 0 " " " "
'D1 SLAVEHA0  = 0 " " " "
'D0 READWRITE = 0 Read/Write Bit = Write
OUT SPIDATA3, &H40

WHILE (INP(SPISTATUS) AND &H1) = &H1: WEND

```

```

'INITIALIZE DIRECTION OF DIO LINES D15-D8 AS INPUTS
'=====

'Direction = All Inputs
OUT SPIDATA1, &HFF

'MCP23S17 IODIRA Register Address
OUT SPIDATA2, &H0

'MCP23S17 SPI Control Byte (Write)
OUT SPIDATA3, &H40

WHILE (INP(SPISTATUS) AND &H1) = &H1: WEND

'Repeat until ESC key is pressed
WHILE INKEY$ <> CHR$(27)

    'READ DIO INPUT DATA FROM MCP23S17
    '-----

    'MCP23S17 GPIOA Register Address
    OUT SPIDATA2, &H12

    'MCP23S17 SPI Control Byte (Read)
    OUT SPIDATA3, &H41

    WHILE (INP(SPISTATUS) AND &H1) = &H1: WEND

    'DIO Input Data
    PRINT HEX$(INP(SPIDATA1))

WEND

SYSTEM

```

Analog Input

The Iguana uses a multi-range, 12-bit Linear Technology LTC1857 A/D converter with eight single-ended input signals (even and odd analog channels, for example inputs 1 and 2, can also be combined as differential inputs). The converter has a 100 kilo-samples-per-second (Ksps) sampling rate, with a 4 μ s acquisition time, with per-channel input ranges of 0 to +5V or 0 to +10V unipolar, and \pm 5V or \pm 10V bipolar

The Iguana A/D converter is controlled using the SPI registers. The A/D converter is accessed via SPI slave select 5 (writing 5h to the SS field in SPICONTROL).

See "SPI Registers" for a complete description of the registers.

See the [Linear Technology LTC1857 A/D Converter Datasheet](#) for programming information.

Warning! Application of analog voltages greater than +25V or less than -25V can damage the converter.

EXTERNAL CONNECTIONS

Single-ended analog voltages are applied to connectors J1 and J2 of the VL-CBR-4004 board (connected to J25 of the Iguana) as shown in the following table.

Table 18: Analog Input Connector

J25 Pin	Signal	VL-CBR-4004 Connector	VL-CBR-4004 Pin (Label)
1	Analog Input 1	J1 Analog Input	5 (IO1)
2	Analog Input 2		4 (IO2)
3	Analog Input 3		3 (IO3)
4	Analog Input 4		2 (IO4)
5	Ground		1 (GND1)
6	Analog Input 5	J2 Analog Input	5 (IO5)
7	Analog Input 6		4 (IO6)
8	Analog Input 7		3 (IO7)
9	Analog Input 8		2 (IO8)
10	Ground		1 (GND1)

ANALOG INPUT USING THE SPI INTERFACE

See "SPI Registers" for a description of the SPI interface and registers.

Initiating an Analog Conversion Using the SPI Interface

The following procedure can be used to initiate an analog conversion using the SPI interface.

1. Write 15h to the SPICONTROL register (I/O address CA8h) – This value configures the SPI port to select the on-board A/D converter, 16-bit frame length, low SCLK idle state, rising edge SCLK edge, and automatic slave select.
2. Write 10h to the SPISTATUS register (I/O address CA9h) – This value selects 2 MHz SCLK speed, hardware IRQ disable, and left-shift data. A 2 MHz clock is used to avoid having to insert a delay after the SPI cycle to wait for the end of the 4 μ s A/D signal acquisition interval. If a 4 MHz SPI clock is used then there must be a delay of 1.5 μ s after the SPI cycle ends before starting an A/D conversion; if an 8 MHz SPI clock is used then there must be a delay of 2.75 μ s after the end of the SPI cycle.
3. Write any value to SPIDATA2 (I/O address CACH) – This data will be ignored by the A/D converter.
4. Write bit 0 of the analog input channel number to bit 6, bits 2-1 of the analog input channel number to bits 5-4, and a 2-bit input range code to bits 3-2 of SPIDATA3 (I/O address CADh). Any write operation to this register triggers an SPI transaction. The 2-bit input-range codes are 0 (± 5 V), 1 (± 10 V), 2 (0 to +5V) or 3 (0 to +10V). Set bit 7 if you wish your conversion to be for a single-ended channel. For example, if converting the 4th A/D channel (channel number 3) with a 0 to +5V range as a single channel then SPIDATA3 is set to d8h.
5. Poll the SPI BUSY bit in the SPISTATUS register until the conversion is completed.
6. Write a '1' to ADCONVST0 Bit 0 of the FPGA ADC, DAC control/status register (I/O address CAFh) to start a conversion
7. Poll the the ADCBUSY0 Bit 2 of the FPGA ADC/DAC control/status register (I/O address CAFh) until this bit is a '0' (not busy) to indicate a conversion is completed (a conversion takes a maximum of 5 μ s).
8. Read the conversion data from SPIDATA3 (upper 8 bits of the 12-bit conversion) and SPIDATA2 (lower 4 bits of the 12-bit conversion are in the upper 4 bits of this byte). The data read is from the previous conversion not the one for the SPI values written in Steps 1–5. Another conversion cycle is required to retrieve that data. Typically a number of channels are sampled at one time so this conversion delay is not significant.

Anytime an SPI command is written to the A/D device a conversion must be issued for that command. Another command will not be accepted until a conversion is performed.

Analog Output

The Iguana uses a 12-bit Linear Technology LTC2634 D/A converter with four (4) single-ended output signals. The converter has 5 μ s per-channel update rate with a 0 to 4.096V output voltage range.

The Iguana D/A converter is controlled using the SPI registers. The D/A converter is accessed via SPI slave select 7 (writing 7h to the SS field in SPICONTROL). See "SPI Registers" for a complete description of the registers.

See the [Linear Technology LTC2634 D/A Converter Datasheet](#) for programming information.

Table 19: Analog Output Pinout

J25 Pin	Signal	VL-CBR-4004 Connector	VL-CBR-4004 Pin (Label)
11	Analog Output 1	J3 Analog Output	5 (IO9)
12	Analog Output 2		4 (IO10)
13	Analog Output 3		3 (IO11)
14	Analog Output 4		2 (IO12)
15	Ground		1 (GND2)

Analog Output Using the SPI Interface

The following procedure can be used to set an analog output using the SPI interface.

1. Write 27h to the SPICONTROL register (I/O address CA8h) – This value configures the SPI port to select the D/A converter, 24-bit frame length, low SCLK idle state, rising edge SCLK edge, and automatic slave select.
2. Write 30h to the SPISTATUS register (I/O address CA9h) – This value selects 8 MHz SCLK speed, hardware IRQ disable, and left-shift data.
3. Write the LS 4-bits of the 12-bit output value into the MS 4-bits of SPIDATA1 (I/O address CABh). For example, if writing a 12-bit value of 123h the value of 30h is written to SPIDATA1.
4. Write the MS 8-bits of the 12-bit output value to SPIDATA2 (I/O address CACH). For example, if writing a 12-bit value of 123h the value of 12h is written to SPIDATA2.
5. Write the analog output channel number (0 to 3) to Bits 3-0 and the write-and-update-channel command 3h to Bits 7-4 of SPIDATA3 (I/O address CADh) – Any write operation to this register triggers an SPI transaction. For example, if writing to the third DAC channel (channel number 2) the value written to SPIDATA3 is 32h.
6. Poll the SPI BUSY bit in the SPISTATUS register until the conversion is completed.
7. The D/A output will be stable in no more than 5 μ s.

Counter / Timers

The Iguana includes two uncommitted 8254 type counter/timer channels for general program use. External control signals for the two channels are available on connector J25.

Table 20: Counter Timer Pinout

J25 Pin	Signal Direction*	Signal Name	Function	VL-CBR-4004 Connector	VL-CBR-4004 Pin (Label)
36	Output	OCTC3	Timer 3 Counter Output	J9	1 (IO29)
37	Input	ICTC3	Timer 3 Clock Input		2 (IO30)
38	Output	OCTC4	Timer 4 Counter Output		3 (IO31)
39	Input	ICTC4	Timer 4 Clock Input		4 (IO32)
40	—	GND	Ground		5 (GND4)

* Relative to VL-EPIC-25

The Custom Programming appendix discusses how to use and configure these timers using the following registers.

Register	Read/Write	Address	Name
IRQCTRL	R/W	CA3h	Interrupt Control Register
IRQSTAT	R-Status/Write-Clear	CA4h	Interrupt Status Register
TMCNTRL	R/W	CA5h	Timer Control Register

SPX

Up to four serial peripheral expansion (SPX) devices can be attached to the Iguana at connector J27 using the VL-CBR-1401 or VL-CBR-1402 cable. The SPX interface provides the standard serial peripheral interface (SPI) signals: SCLK, MISO, and MOSI, as well as four chip selects, SS0# to SS3#, and an interrupt input, SINT#.

The +5V power provided to pins 1 and 14 of J27 is protected by a 1 Amp resettable fuse.

Table 21: SPX Expansion Bus Pinout

J27 Pin	Signal Name	Function
1	V5_0	+5V (Protected)
2	SCLK	Serial Clock
3	GND	Ground
4	MISO	Serial Data In
5	GND	Ground
6	MOSI	Serial Data Out
7	GND	Ground
8	SS0#	Chip Select 0
9	SS1#	Chip Select 1
10	SS2#	Chip Select 2
11	SS3#	Chip Select 3
12	GND	Ground
13	SINT#	Interrupt Input
14	V5_0	+5V (Protected)

SPI is, in its simplest form, a three wire serial bus. One signal is a Clock, driven only by the permanent Master device on-board. The others are Data In and Data Out with respect to the Master. The SPX implementation adds additional features, such as chip selects and an interrupt input to the Master. The Master device initiates all SPI transactions. A slave device responds when its Chip Select is asserted and it receives Clock pulses from the Master.

The SPI clock rate can be software configured to operate at speeds between 1 MHz and 8 MHz. Please note that since this clock is divided from a 33 MHz PCI clock, the actual generated frequencies are not discrete integer MHz frequencies. All four common SPI modes are supported through the use of clock polarity and clock idle state controls.

This SPX interface is also used as a manufacturing test interface to output data from the internal LPC bus (primarily for I/O Port 80 codes). When there is no SPX module installed, there will be signal activity on this SPX connector (for example, the 33 MHz LPC clock will be on the SCLK pin 2). This mode can be disabled by grounding pin 5 on J27, and the interface will function normally as an SPX interface. It can also be permanently disabled by adding stuffing resistors on the board.

VERSALOGIC SPX EXPANSION MODULES

VersaLogic offers a number of SPX modules that provide a variety of standard functions, such as analog input, digital I/O, CANbus controller, and others. These are small boards (1.2" x 3.78") that can mount on the PC/104 stack, using standard standoffs, or up to two feet away from the baseboard. For more information, contact VersaLogic at info@VersaLogic.com.

SPI REGISTERS

A set of control and data registers are available for SPI transactions. The following tables describe the SPI control registers (SPICONTROL and SPISTATUS) and data registers (SPIDATA3-0).

SPICONTROL (READ/WRITE) CA8h

D7	D6	D5	D4	D3	D2	D1	D0
CPOL	CPHA	SPILEN1	SPILEN0	MAN_SS	SS2	SS1	SS0

Table 22: SPI Control Register 1 Bit Assignments

Bit	Mnemonic	Description																																				
D7	CPOL	SPI Clock Polarity – Sets the SCLK idle state. 0 = SCLK idles low 1 = SCLK idles high																																				
D6	CPHA	SPI Clock Phase – Sets the SCLK edge on which valid data will be read. 0 = Data read on rising edge 1 = Data read on falling edge																																				
D5-D4	SPILEN	SPI Frame Length – Sets the SPI frame length. This selection works in manual and auto slave select modes. <table border="1"> <thead> <tr> <th>SPILEN1</th> <th>SPILEN0</th> <th>Frame Length</th> </tr> </thead> <tbody> <tr> <td>0</td> <td>0</td> <td>8-bit</td> </tr> <tr> <td>0</td> <td>1</td> <td>16-bit</td> </tr> <tr> <td>1</td> <td>0</td> <td>24-bit</td> </tr> <tr> <td>1</td> <td>1</td> <td>32-bit</td> </tr> </tbody> </table>	SPILEN1	SPILEN0	Frame Length	0	0	8-bit	0	1	16-bit	1	0	24-bit	1	1	32-bit																					
SPILEN1	SPILEN0	Frame Length																																				
0	0	8-bit																																				
0	1	16-bit																																				
1	0	24-bit																																				
1	1	32-bit																																				
D3	MAN_SS	SPI Manual Slave Select Mode – This bit determines whether the slave select lines are controlled through the user software or are automatically controlled by a write operation to SPIDATA3 (CADh). If MAN_SS = 0, then the slave select operates automatically; if MAN_SS = 1, then the slave select line is controlled manually through SPICONTROL bits SS2, SS1, and SS0. 0 = Automatic, default 1 = Manual																																				
D2-D0	SS	SPI Slave Select – These bits select which slave select will be asserted. The SSx# pin on the baseboard will be directly controlled by these bits when MAN_SS = 1. <table border="1"> <thead> <tr> <th>SS2</th> <th>SS1</th> <th>SS0</th> <th>Slave Select</th> </tr> </thead> <tbody> <tr> <td>0</td> <td>0</td> <td>0</td> <td>None, port disabled</td> </tr> <tr> <td>0</td> <td>0</td> <td>1</td> <td>SPX Slave Select 0, J27 pin-8</td> </tr> <tr> <td>0</td> <td>1</td> <td>0</td> <td>SPX Slave Select 1, J27 pin-9</td> </tr> <tr> <td>0</td> <td>1</td> <td>1</td> <td>SPX Slave Select 2, J27 pin-10</td> </tr> <tr> <td>1</td> <td>0</td> <td>0</td> <td>SPX Slave Select 3, J27 pin-11</td> </tr> <tr> <td>1</td> <td>0</td> <td>1</td> <td>A/D Converter (on-board)</td> </tr> <tr> <td>1</td> <td>1</td> <td>0</td> <td>Digital I/O (on-board)</td> </tr> <tr> <td>1</td> <td>1</td> <td>1</td> <td>D/A Converter (on-board)</td> </tr> </tbody> </table>	SS2	SS1	SS0	Slave Select	0	0	0	None, port disabled	0	0	1	SPX Slave Select 0, J27 pin-8	0	1	0	SPX Slave Select 1, J27 pin-9	0	1	1	SPX Slave Select 2, J27 pin-10	1	0	0	SPX Slave Select 3, J27 pin-11	1	0	1	A/D Converter (on-board)	1	1	0	Digital I/O (on-board)	1	1	1	D/A Converter (on-board)
SS2	SS1	SS0	Slave Select																																			
0	0	0	None, port disabled																																			
0	0	1	SPX Slave Select 0, J27 pin-8																																			
0	1	0	SPX Slave Select 1, J27 pin-9																																			
0	1	1	SPX Slave Select 2, J27 pin-10																																			
1	0	0	SPX Slave Select 3, J27 pin-11																																			
1	0	1	A/D Converter (on-board)																																			
1	1	0	Digital I/O (on-board)																																			
1	1	1	D/A Converter (on-board)																																			

SPISTATUS (READ/WRITE) CA9h

D7	D6	D5	D4	D3	D2	D1	D0
IRQSEL1	IRQSEL0	SPICLK1	SPICLK0	HW_IRQ_EN	LSBIT_1ST	HW_INT	BUSY

Table 23: SPI Control Register 2 Bit assignments

Bit	Mnemonic	Description															
D7-D6	IRQSEL	<p>IRQ Select – These bits select which IRQ will be asserted when a hardware interrupt from a connected SPI device occurs. The HW_IRQ_EN bit must be set to enable SPI IRQ functionality.</p> <table border="1"> <tr> <td>IRQSEL1</td> <td>IRQSEL0</td> <td>IRQ</td> </tr> <tr> <td>0</td> <td>0</td> <td>IRQ3</td> </tr> <tr> <td>0</td> <td>1</td> <td>IRQ4</td> </tr> <tr> <td>1</td> <td>0</td> <td>IRQ5</td> </tr> <tr> <td>1</td> <td>1</td> <td>IRQ10</td> </tr> </table>	IRQSEL1	IRQSEL0	IRQ	0	0	IRQ3	0	1	IRQ4	1	0	IRQ5	1	1	IRQ10
IRQSEL1	IRQSEL0	IRQ															
0	0	IRQ3															
0	1	IRQ4															
1	0	IRQ5															
1	1	IRQ10															
D5-D4	SPICLK	<p>SPI SCLK Frequency – These bits set the SPI clock frequency.</p> <table border="1"> <tr> <td>SPICLK1</td> <td>SPICLK0</td> <td>Frequency</td> </tr> <tr> <td>0</td> <td>0</td> <td>1.042 MHz</td> </tr> <tr> <td>0</td> <td>1</td> <td>2.083 MHz</td> </tr> <tr> <td>1</td> <td>0</td> <td>4.167 MHz</td> </tr> <tr> <td>1</td> <td>1</td> <td>8.333 MHz</td> </tr> </table>	SPICLK1	SPICLK0	Frequency	0	0	1.042 MHz	0	1	2.083 MHz	1	0	4.167 MHz	1	1	8.333 MHz
SPICLK1	SPICLK0	Frequency															
0	0	1.042 MHz															
0	1	2.083 MHz															
1	0	4.167 MHz															
1	1	8.333 MHz															
D3	HW_IRQ_EN	<p>Hardware IRQ Enable – Enables or disables the use of the selected IRQ (IRQSEL) by an SPI device. 0 = SPI IRQ disabled, default 1 = SPI IRQ enabled</p> <p>Note: The selected IRQ is shared with PC/104 ISA bus devices. CMOS settings must be configured for the desired ISA IRQ.</p>															
D2	LSBIT_1ST	<p>SPI Shift Direction – Controls the SPI shift direction of the SPIDATA registers. The direction can be shifted toward the least significant bit or the most significant bit. 0 = SPIDATA data is left-shifted (MSbit first), default 1 = SPIDATA data is right-shifted (LSbit first)</p>															
D1	HW_INT	<p>SPI Device Interrupt State – This bit is a status flag that indicates when the hardware SPX signal SINT# is asserted. 0 = Hardware interrupt on SINT# is deasserted 1 = Interrupt is present on SINT#</p> <p>This bit is read-only and is cleared when the SPI device’s interrupt is cleared.</p>															
D0	BUSY	<p>SPI Busy Flag – This bit is a status flag that indicates when an SPI transaction is underway. 0 = SPI bus idle 1 = SCLK is clocking data in and out of the SPIDATA registers</p> <p>This bit is read-only.</p>															

SPIDATA0 (READ/WRITE) CAAh

D7	D6	D5	D4	D3	D2	D1	D0
MSbit							LSbit

SPIDATA1 (READ/WRITE) CABh

D7	D6	D5	D4	D3	D2	D1	D0
MSbit							LSbit

SPIDATA2 (READ/WRITE) CACH

D7	D6	D5	D4	D3	D2	D1	D0
MSbit							LSbit

SPIDATA3 (READ/WRITE) CADh

D7	D6	D5	D4	D3	D2	D1	D0
MSbit							LSbit

SPIDATA3 contains the most significant byte (MSB) of the SPI data word. A write to this register will initiate the SPI clock and, if the MAN_SS bit = 0, will also assert a slave select to begin an SPI bus transaction. Increasing frame sizes from 8-bit uses the lowest address for the least significant byte of the SPI data word; for example, the LSB of a 24-bit frame would be SPIDATA1. Data is sent according to the LSBIT_1ST setting. When LSBIT_1ST = 0, the MSbit of SPIDATA3 is sent first, and received data will be shifted into the LSbit of the selected frame size set in the SPILEN field. When LSBIT_1ST = 1, the LSbit of the selected frame size is sent first, and the received data will be shifted into the MSbit of SPIDATA3.

Data returning from the SPI target will normally have its most significant data in the SPIDATA3 register. An exception will occur when LSBIT_1ST = 1 to indicate a right-shift transaction. In this case the most significant byte of an 8-bit transaction will be located in SPIDATA0, a 16-bit transaction's most significant byte will be located in SPIDATA1, and a 24-bit transaction's most significant byte will be located in SPIDATA2.

System Resources and Maps

Legacy Memory Map

The lower 1 MB memory map of the Iguana is arranged as shown in the following table. Various blocks of memory space between A0000h and FFFFFh are shadowed.

Table 24: Memory Map

Start Address	End Address	Comment
F0000h	FFFFFh	System BIOS Area
E0000h	EFFFFh	Extended System BIOS Area
D0000h	DFFFFh	ISA Expansion Area
C0000h	CFFFFh	Video BIOS Area
A0000h	BFFFFh	Legacy Video Area
00000h	9FFFFh	Legacy System (DOS) Area

I/O Map

The following table lists the common I/O devices in the Iguana I/O map. User I/O devices should be added using care to avoid the devices already in the map as shown below.

Table 25: On-Board I/O Devices

I/O Device	Standard I/O Addresses
Reserved	CB4h-CBFh
PLD Internal 8254 Timers	CB0h-CB3h
ADC/DAC Control/Status Register	CAFh
mSATA/PCIe Mux Control Register	CAEh
SPI Data Register 3	CADh
SPI Data Register 2	CACH
SPI Data Register 1	CABh
SPI Data Register 0	CAAh
SPI Status Register	CA9h
SPI Control Register	CA8h
Reserved	CA6h-CA7h
Timer Control Register	CA5h
Interrupt Status Register	CA4h
Interrupt Control Register	CA3h
BIOS and Jumper Status Register	CA2h
Revision Indicator Register	CA1h
PLED and Product ID Register	CA0h
Reserved	C80h-C9Fh
Super I/O Runtime Registers	C00h-C80h
COM1 Serial Port Default	3F8h-3FFh
COM2 Serial Port Default	2F8h-2FFh
Primary IDE Controller for Compact Flash	1F0h-1F7h



PLED and Product Code Register

PLEDPC (Read/Write) CA0h

D7	D6	D5	D4	D3	D2	D1	D0
PLED	PC6	PC5	PC4	PC3	PC2	PC1	PC0

Table 26: PLED and Product Code Register Bit Assignments

Bit	Mnemonic	Description																
D7	PLED	Light Emitting Diode — Controls the programmable LED on connector J7. 0 = Turns LED off 1 = Turns LED on																
D6-D0	PC	Product Code — These bits are hard-coded to represent the product type. The Iguana always reads as 0000011. Other codes are reserved for future products. <table border="0" style="margin-left: 20px;"> <tr> <td>PC6</td> <td>PC5</td> <td>PC4</td> <td>PC3</td> <td>PC2</td> <td>PC1</td> <td>PC0</td> <td>Product Code</td> </tr> <tr> <td>0</td> <td>0</td> <td>0</td> <td>1</td> <td>0</td> <td>1</td> <td>1</td> <td>VL-EPIC-25</td> </tr> </table> These bits are read-only.	PC6	PC5	PC4	PC3	PC2	PC1	PC0	Product Code	0	0	0	1	0	1	1	VL-EPIC-25
PC6	PC5	PC4	PC3	PC2	PC1	PC0	Product Code											
0	0	0	1	0	1	1	VL-EPIC-25											

PLD Revision and Type Register

REVTYP (Read Only) CA1h

D7	D6	D5	D4	D3	D2	D1	D0
PLD4	PLD3	PLD2	PLD1	PLD0	TEMP	CUSTOM	BETA

This register is used to indicate the revision level of the Iguana.

Table 27: Revision and Type Register Bit Assignments

Bit	Mnemonic	Description																																				
D7-D3	PLD	<p>PLD Code Revision Level — These bits are hard-coded and represent the PLD code revision.</p> <table border="1"> <thead> <tr> <th>PLD4</th> <th>PLD3</th> <th>PLD2</th> <th>PLD1</th> <th>PLD0</th> <th>Revision</th> </tr> </thead> <tbody> <tr> <td>0</td> <td>0</td> <td>0</td> <td>0</td> <td>0</td> <td>Rev. 0. 10B</td> </tr> <tr> <td>0</td> <td>0</td> <td>0</td> <td>0</td> <td>1</td> <td>Rev. 0. 10B</td> </tr> <tr> <td>0</td> <td>0</td> <td>0</td> <td>1</td> <td>0</td> <td>Rev. 0. 20A</td> </tr> <tr> <td>0</td> <td>0</td> <td>0</td> <td>1</td> <td>1</td> <td>Rev. 1. 00A</td> </tr> <tr> <td>0</td> <td>0</td> <td>1</td> <td>0</td> <td>0</td> <td>Rev. 1. 01A</td> </tr> </tbody> </table> <p>These bits are read-only. Note: For beta boards, the Revision Level is set to 1.00A, but the Production Level is set to Beta.</p>	PLD4	PLD3	PLD2	PLD1	PLD0	Revision	0	0	0	0	0	Rev. 0. 10B	0	0	0	0	1	Rev. 0. 10B	0	0	0	1	0	Rev. 0. 20A	0	0	0	1	1	Rev. 1. 00A	0	0	1	0	0	Rev. 1. 01A
PLD4	PLD3	PLD2	PLD1	PLD0	Revision																																	
0	0	0	0	0	Rev. 0. 10B																																	
0	0	0	0	1	Rev. 0. 10B																																	
0	0	0	1	0	Rev. 0. 20A																																	
0	0	0	1	1	Rev. 1. 00A																																	
0	0	1	0	0	Rev. 1. 01A																																	
D2	Reserved	This bit is reserved.																																				
D1	CUSTOM	<p>PLD Class — This bit indicates whether the PLD code is standard or customized.</p> <p>0 = Standard PLD code 1 = Custom PLD code</p> <p>This bit is read-only.</p>																																				
D0	BETA	<p>Production Level — This bit indicates if the PLD code is at the beta or production level.</p> <p>0 = Production level PLD 1 = Beta level PLD</p> <p>This bit is read-only.</p>																																				

BIOS and Jumper Status Register

BIOSJSR (Read/Write) CA2h

D7	D6	D5	D4	D3	D2	D1	D0
BIOS_JMP	BIOS_OR	BIOS_SEL	Reserved	Reserved	Reserved	Reserved	GPI_JMP

Table 28: Special Control Register Bit Assignments

Bit	Mnemonic	Description
D7	BIOS_JMP	System BIOS Selector Jumper Status — Indicates the status of the system BIOS selector jumper at V5 [1-2]. 0 = Jumper installed – backup system BIOS selected 1 = No jumper installed – primary system BIOS selected This bit is read-only.
D6	BIOS_OR	BIOS Jumper Override — Overrides the system BIOS selector jumper and selects the BIOS with BIOS_SEL. 0 = No BIOS override 1 = BIOS override
D5	BIOS_SEL	BIOS Select — Selects the system BIOS when BIOS_OR is set. 0 = Backup BIOS selected 1 = Primary BIOS selected
D4-D2	Reserved	These bits are reserved. Only write 0 to these bits and ignore all read values.
D1	GPI_JMP	General Purpose Jumper Status – Indicates the status of the general purpose jumper at V5 [3-4].
D0	Reserved	This bit is reserved. Only write 0 to this bit and ignore all read values.

Appendix A – References



CPU <i>Intel Atom D425/D525 Dual Core</i>	Intel Atom Datasheet Vol. 1 and Vol. 2
Chipset <i>Intel ICH8</i>	Intel ICH8 Datasheet
Super I/O Chip <i>SMSC SCH3114</i>	SCH3114 Datasheet
Ethernet Controller <i>Intel 82574IT Ethernet Controller</i>	Intel 82574IT Datasheet
PC/104 Interface	PC/104 Specification
PC/104-Plus Interface	PC/104-Plus Specification

Appendix B – Custom Programming



PLD Interrupts

The PLD can generate interrupts for the internal 8254 timers and the external SPI interrupt (which includes the DIO device interrupt). The SPI interrupt settings are discussed in the section on “SPX Expansion Bus.” This section covers the interrupt settings for the 8254 timers.

INTERRUPT CONTROL REGISTER

This register enables interrupts.

IRQCTRL (Read/Write) CA3h

D7	D6	D5	D4	D3	D2	D1	D0
IRQEN	IRQSEL2	IRQSEL1	IRQSEL0	reserved	IMSK_TC5	IMSK_TC4	IMSK_TC3

Table 29: Interrupt Control Register Bit Assignments

Bit	Mnemonic	Description
D7	IRQEN	IRQ Enable — Enables or disables an interrupt. 0 = Disable interrupt 1 = Enable interrupt
D6-D5	IRQSEL(2:0)	Specifies the interrupt mapping (this setting is ignored when IRQEN = 0 ... interrupts are disabled): "000" IRQ3 (default) "001" IRQ4 "010" IRQ5 "011" IRQ10 "100" IRQ6 "101" IRQ7 "110" IRQ9 "111" IRQ11
D4	Reserved	These bits are reserved. Only write 0 to these bits and ignore all read values.
D2	IMASK_TC5	Mask for the 8254 Timer #5 output (terminal count) Interrupt. 0 = Disable interrupt 1 = Enable interrupt
D1	IMASK_TC4	Mask for the 8254 Timer #4 output (terminal count) Interrupt. 0 = Disable interrupt 1 = Enable interrupt
D0	IMASK_TC3	Mask for the 8254 Timer #3 output (terminal count) Interrupt. 0 = Disable interrupt 1 = Enable interrupt

Note: IRQ3, IRQ4, IRQ5, IRQ10 are also defined for the SPX interface interrupts. If one of these interrupts is selected for the SPX interface and also enabled here for the timer interrupts, then the interrupt sources are combined (i.e., logically OR'd).

INTERRUPT STATUS REGISTER

This register is used for reading the status of interrupts generated by the PLD.

IRQSTAT (Read-Status/Write-Clear) CA4h

D7	D6	D5	D4	D3	D2	D1	D0
Reserved	Reserved	Reserved	Reserved	Reserved	ISTAT_TC5	ISTAT_TC4	ISTAT_TC3

Table 30: Interrupt Status Register Bit Assignments

Bit	Mnemonic	Description
D7-D3	Reserved	These bits are reserved. Only write 0 to these bits and ignore all read values.
D2	ISTAT_TC5	Status for the 8254 Timer #5 output (terminal count) Interrupt when read. 0 = Timer output (terminal count) has not transitioned from 0 to a 1 level 1 = Timer output (terminal count) has transitioned from a 0 to a 1 level This bit is read-status and a write-1-to-clear.
D1	ISTAT_TC4	Status for the 8254 Timer #4 output (terminal count) Interrupt when read. 0 = Timer output (terminal count) has not transitioned from 0 to a 1 level 1 = Timer output (terminal count) has transitioned from a 0 to a 1 level This bit is read-status and a write-1-to-clear.
D0	ISTAT_TC3	Status for the 8254 Timer #3 output (terminal count) Interrupt when read. 0 = Timer output (terminal count) has not transitioned from 0 to a 1 level 1 = Timer output (terminal count) has transitioned from a 0 to a 1 level This bit is read-status and a write-1-to-clear.

The interrupt status register is valid whether the interrupt mask is set or not for the interrupt (that is, it can be used for polled status). An interrupt status is acknowledged (cleared to a 0) by writing a '1' to the status bit.

The PLD implements an 8254 timer (consisting of three individual timers). The outputs of these timers can generate interrupts when they transition from a 0 level to a 1 level (edge sensitive).

8254 Timer Control Register

This register is used to set modes related to the inputs on the 8254 Timers.

TIMCNTRL (Read/Write) CA5h

D7	D6	D5	D4	D3	D2	D1	D0
TIM5GATE	TIM4GATE	TIM3GATE	TM4MODE	TM4SEL	TM3SEL	Reserved	Reserved

Table 31: 8254 Timer Control Register Bit Assignments

Bit	Mnemonic	Description
D7	TIM5GATE	Sets the level on the Gate input for the 8254 Timer #5. 0 = GCTC5 Gate is disabled (set to a logic 0) 1 = GCTC5 Gate is enabled (set to a logic 1)
D6	TIM4GATE	Sets the level on the Gate input for the 8254 Timer #4. 0 = GCTC4 Gate is disabled (set to a logic 0) 1 = GCTC4 Gate is enabled (set to a logic 1)
D5	TIM3GATE	Sets the level on the Gate input for the 8254 Timer #3. 0 = GCTC3 Gate is disabled (set to a logic 0) 1 = GCTC3 Gate is enabled (set to a logic 1)
D4	TM4MODE	Configure how the 8254 Timer #4 and #5 are used. 0 – Timer #4 is cascaded with Timer #5 for a 32-bit timer 1 – Timer #4 operates in normal 16-bit mode
D3	TM4SEL	Configure the clock source for 8254 Timer #4. 0 – Timer #4 input clock is 4.167 MHz internal clock (PCI clock divided by 8) 1 – Timer #4 input clock is from User I/O connector Input ICTC4
D2	TM3SEL	Configure the clock source for 8254 Timer #3. 0 – Timer #3 input clock is 4.167 MHz internal clock (PCI clock divided by 8) 1 – Timer #3 input clock is from User I/O connector Input ICTC3
D1-D0	Reserved	These bits are reserved. Only write 0 to these bits and ignore all read values.

An 8254 timer is implemented in the PLD (see Table 25: On-Board I/O Devices for I/O addresses). It contains three independent 16-bit timers. It is fully software compatible with the Intel 8254, except that only binary counting modes are implemented (the BCD control bit is implemented but ignored). See the [Intel 82C54 Programmable Interval Timer Datasheet](#) for register definitions and programming information.

There is an option to cascade two of the timers together in a 32-bit mode. The timers are identified as Timer 3, 4, and 5. When Timers 4 and 5 are cascaded, Timer 4 is the LS 16-bits and Timer 5 is the MS 16-bits. In this 32-bit cascade mode the timer output of Timer 4 feeds the clock input of Timer 5. In this mode Timer 4 would normally be set so that it generates a clock after counting the full 16-bit range, but there is no requirement to do this.

The 32-bit cascade mode is set in TM4MODE in the Timer Control Register. There are also internal or external clock selections for the timers in this register using the external clocks ICTC3 and ICTC4 signals on the connector at J25. The internal clock is the PCI clock divided by 8 (33.33 MHz / 8 = 4.167 MHz). ICTC3 can only be used with Timer 3. ICTC4 can only be used with Timer 4. The clock for Timer 5 is always the internal clock except in the 32-bit cascade mode when the output from Timer 4 is the clock for Timer 5.

The timer outputs can generate interrupts. When a timer output transitions from a 0 to a 1 then an interrupt status bit is set and can generate an interrupt. This bit sticks until cleared.

By default there are two external timer input clocks (ICTC3, ICTC4) and two timer outputs (OCTC3, OCTC4) on connector J25. To use all three of the 16-bit timers, timers 4 and 5 are configured in 32-bit mode by default. Custom options are available that can expand the external controls to allow for three clock inputs and four, timer outputs as well as three timer gate inputs for all three 16-bit timers by using some of the digital I/O signal pins on J25.

A/D and D/A Control/Status Register

This register is used to control A/D and D/A conversion.

ADCONSTAT (Read/Write) CAFh

D7	D6	D5	D4	D3	D2	D1	D0
Reserved	Reserved	Reserved	DACLDA0	Reserved	ADCBUSY0	Reserved	ADCONVST0

Table 32: A/D, D/A Control/Status Register Bit Assignments

Bit	Mnemonic	Description
D7-D6	Reserved	These bits are reserved. Only write 0 to these bits and ignore all read values.
D5	Reserved	This bit is reserved. Only write 0 to this bit and ignore read values.
D4	DACLDA0	This is a write-only (pulsed) bit. When a '1' is written it will strobe the LDAC signal on the LTC2634 D/A Converter. Writing a '0' is ignored.
D3	Reserved	This bit is reserved. Only write 0 to this bit and ignore read values.
D2	ADCBUSY0	This read-only status bit returns the A/D conversion status. 0 – A/D is not busy doing a conversion. 1 – A/D is busy doing a conversion.
D1	Reserved	This bit is reserved. Only write 0 to this bit and ignore read values.
D0	ADCONVST0	This is a write-only (pulsed) bit. When a '1' is written it will start a conversion on the LTC1857 A/D converter. Writing a '0' is ignored.